

# SURVEYLOG

BERNTSEN® SURVEY PRODUCTS CATALOG • THE SOURCE FOR YOUR SURVEY PRODUCT NEEDS



Find Us Online  
[www.berntsen.com](http://www.berntsen.com)



Order By Phone  
800.356.7388



Contact By Email  
[surveymark@berntsen.com](mailto:surveymark@berntsen.com)

# Berntsen®

Marking the Infrastructure of the World™

The year 2013 ushers Berntsen International into its 5th decade of manufacturing American-made monuments for land surveyors and engineers. Berntsen products are used throughout all 50 states and around the world. We have recently created a map that will take you around the globe featuring famous monuments we have produced for our customers over the years. Log on to <http://www.berntsen.com/Famous-Monuments/Monuments-Map>. It's history in the making that you and your family will enjoy.

Our product line has evolved from one basic survey monument to hundreds of products. **Innovation, quality and customer service** drive all that we do. The entire Berntsen team is engaged in giving you, our customer, our very best in products and services.

Our website also encompasses these values. If you haven't visited our site recently, we ask you to stop by. Our customers tell us that ordering on the Berntsen website is convenient, quick, and easy. Berntsen's newest items can always be found there – such as the new Berntsen Inframarker System™. This is the latest in RFID technology and you can read about it on pages 34 and 35 of this catalog.

Of course, we are always ready to discuss your requirements and project needs. Whether by phone, email, in person or via Live Chat on the web, we are always happy to help! It is truly a pleasure to serve you.

*Rhonda L. Rushing*  
Rhonda L. Rushing  
President



FIND US ON FACEBOOK AND YOUTUBE

#### TO CONTACT US:

Our office hours are:  
**MONDAY-FRIDAY**  
**8:00 am - 4:30 pm**  
**Central Time**

**Telephone:** NORTH AMERICA: 800-356-7388 (Toll-free)  
Outside NORTH AMERICA: 1-608-249-8549  
**Fax:** NORTH AMERICA: 800-249-9794 (Toll-free)  
Outside NORTH AMERICA: 1-608-249-9794  
**Mail:** BERNTSEN INTERNATIONAL, INC.  
PO BOX 8670  
MADISON, WISCONSIN 53708-8670 USA  
**Email:** [surveymark@berntsen.com](mailto:surveymark@berntsen.com)  
**Website:** [www.berntsen.com](http://www.berntsen.com)



Left to Right: Bill Rushing, Vice President, Rhonda Rushing, President, Phil Peterson, Founder and Chairman of the Board.)

#### LASTING IMPRESSIONS®

by Rhonda L. Rushing,  
President of Berntsen International, Inc.  
With sumptuous photography and original writing in many voices, *Lasting Impressions®* appeals to surveyors and all who cherish American history and geography. *Lasting Impressions®* brings together compelling first-hand stories from around the United States and gives a glimpse into the legacy of land surveying.

Lasting Impressions **29.95**



**Shipping:** 3801 Hanson Road  
Madison, Wisconsin 53704-2501 USA  
Global Address: 43° 09' 12.8333340" N  
89° 01' 15.5213676" W  
Elevation: 237.442 m

If you are ever in the Madison area we invite you to our facility. We are located off US Highway 51 (north of the Madison airport) at 3801 Hanson Road.

We accept MASTERCARD®, VISA®, DISCOVER®, and AMERICAN EXPRESS®



## Become a BERNTSEN FAN on Facebook!

Berntsen Survey Markers Facebook page is a portal for surveyors, engineers, utility & construction contractors to stay up-to-date with all that is going on at Berntsen International Inc.. Discover sale events, browse photos & videos of our product offerings, share your own photos, and be the first to hear about Berntsen promotions and company news.

**Sign up today at**  
[www.berntsen.com/Facebook](http://www.berntsen.com/Facebook)

|   |             |
|---|-------------|
| <b>ACCESSORIES</b>                            |             |
| Stamping Anvils                               | 23          |
| Field Bags                                    | 18          |
| Hammers                                       | 22          |
| Rebar Drivers                                 | 22          |
| Stake Drivers                                 | 22          |
| Stamp Sets                                    | 23          |
| Traffic Safety Signs                          | 22          |
| <b>CONCRETE MARKERS</b>                       |             |
| Aluminum Markers                              | 14          |
| Bronze Markers                                | 14 & 17     |
| Leveling Markers                              | 14          |
| Countersink Drill Bits                        | 15 & 17     |
| Drylok Cement                                 | 16          |
| <b>FLAGGING, TARGETS &amp; PRISMS</b>         |             |
| Aerial Targets                                | 21          |
| Roll Flagging & Flags                         | 21          |
| Surveying Targets & Prisms                    | 28 - 29     |
| <b>DRILLS &amp; BREAKERS</b>                  |             |
| Bosch Rotary Hammer Drills                    | 16          |
| Cobra Combi                                   | 25          |
| <b>LOCATORS</b>                               |             |
| Magnetic Locators                             | 24          |
| <b>SURVEY MONUMENTS</b>                       |             |
| Access Covers                                 | 8           |
| Drive In                                      | 5           |
| Feno  | 9           |
| Pipe  | 4           |
| Rod   | 6 - 7       |
| <b>REBAR &amp; PIPE CAPS</b>                  |             |
| Metal   | 10 - 11, 18 |
| Plastic                                       | 12 - 13     |
| <b>SIGNS, WITNESS POSTS</b>                   |             |
| Carsonite Posts                               | 26 - 27     |
| Plastic Signs                                 | 27          |
| <b>SPECIALTY MARKERS &amp; CONTROL POINTS</b> |             |
| Bench Tie                                     | 20          |
| Cemetery                                      | 18          |
| EcoStake                                      | 18 & 20     |
| InfraMarker System                            | 34 - 35     |
| Magnetic Markers (Deep-1)                     | 20          |
| Survey Nails                                  | 19          |
| Survey Washers                                | 19          |

**Monuments 04-09**

**Rebar & Pipe Caps 10-13**

**Concrete Markers 14 & 17**

**Countersink  
Drill Bits 15 & 17**

**Drills & Breakers 16 & 25**

**Specialty Markers &  
Control Points 18-20**

**Flagging, Targets  
& Prisms 21, 28-29**

**Accessories 22-23**

**Magnetic Locators 24**

**Signs &  
Witness Posts 26-27**

**InfraMarker  
System 34-35**

Our Berntsen® baseball cap is included on all orders of \$250 or more—FREE. You can purchase them separately for co-workers, friends and family for \$9.95 each. \*Cap style and color may vary.



# Customize Your Monuments!

See page 32 for details



## BERNTSEN® MAGNETIC PIPE MONUMENTS

Berntsen magnetic pipe monuments are offered in standard, flared and breakaway models designed to meet your surveying needs.

Features include:

- 3-1/4" customizable cap
- custom lengths available
- ease of installation
- exceeds federal specifications
- corrosion resistant
- fastest delivery in the industry
- permanent magnet for easy location

### A. FLARED AND NOTCHED-BASE MONUMENTS — easy to set and they STAY PUT!

30" Flared or notched-base monuments are available in aluminum, stainless steel and iron pipe. All stainless steel and iron pipe monuments come with a bronze cap, and **all pipe monuments come with a permanent magnet**. Berntsen® notched-base monuments **exceed federal specifications**. Pipe can be shipped flared or can be flared in the field.

| Item #          | Description   | 1-10           | 11-24        | 25-99        | 100+         |
|-----------------|---|----------------|--------------|--------------|--------------|
| <b>A1NB30</b>   | 30" Aluminum Notched Base (Not Flared)                    | <b>35.77</b>   | <b>23.49</b> | <b>19.77</b> | <b>18.91</b> |
| <b>A1NBF30</b>  | 30" Aluminum Notched Base (Flared)                        | <b>35.77</b>   | <b>23.49</b> | <b>19.77</b> | <b>18.91</b> |
| <b>A1NB36</b>   | 36" Aluminum Notched Base (Not Flared)                    | <b>41.09</b>   | <b>29.93</b> | <b>26.44</b> | <b>25.12</b> |
| <b>A1NBF36</b>  | 36" Aluminum Notched Base (Flared)                        | <b>41.09</b>   | <b>29.93</b> | <b>26.44</b> | <b>25.12</b> |
| <b>SS5NBF30</b> | 30" Stainless Steel Schedule 5 Notched Base (Flared)      | Call for Price |              |              |              |
| <b>SSBNB30</b>  | 30" Stainless Steel Schedule 10 Notched Base (Not Flared) | Call for Price |              |              |              |
| <b>SSBNBF30</b> | 30" Stainless Steel Schedule 10 Notched Base (Flared)     | Call for Price |              |              |              |
| <b>IPNB30</b>   | 30" Iron Pipe Base Monument (Not Flared)                  | <b>78.58</b>   | <b>75.22</b> | <b>70.72</b> | <b>65.48</b> |
| <b>IPNBF30</b>  | 30" Iron Pipe Base Monument (Flared)                      | <b>78.58</b>   | <b>75.22</b> | <b>70.72</b> | <b>65.48</b> |

### B. STANDARD ALUMINUM MONUMENTS — built-in magnet makes them easy to find

30" Standard aluminum pipe monument with cast aluminum base that houses a strong, permanent magnet.

|             |  |              |              |              |              |
|-------------|--|--------------|--------------|--------------|--------------|
| <b>A130</b> | 30" Aluminum Standard (Cast Magnetic Base) | <b>55.99</b> | <b>45.20</b> | <b>38.85</b> | <b>37.50</b> |
| <b>A136</b> | 36" Aluminum Standard (Cast Magnetic Base) | <b>59.07</b> | <b>49.21</b> | <b>44.85</b> | <b>42.23</b> |

### C. BREAK-OFF MONUMENTS — location is preserved even if caps are knocked off

The break-off pipe monument is 30". When base and cap are added the overall length is about 34". These monuments are available with aluminum or polystyrene bases, and aluminum, stainless steel or PVC pipe.

|               |  |              |              |              |              |
|---------------|--|--------------|--------------|--------------|--------------|
| <b>A1BR30</b> | 30" Aluminum Break-Off (Alum. Cap, Pipe, & Base)     | <b>62.71</b> | <b>47.84</b> | <b>43.37</b> | <b>41.86</b> |
| <b>A1BR36</b> | 36" Aluminum Break-Off (Alum. Cap, Pipe, & Base)     | <b>65.58</b> | <b>51.30</b> | <b>47.26</b> | <b>45.45</b> |
| <b>A2BR30</b> | 30" Alum. Break-Off (Alum. Cap & Pipe, Plastic Base) | <b>49.91</b> | <b>35.52</b> | <b>31.15</b> | <b>30.05</b> |
| <b>A2BR36</b> | 36" Alum. Break-Off (Alum. Cap & Pipe, Plastic Base) | <b>53.56</b> | <b>41.38</b> | <b>36.07</b> | <b>34.47</b> |
| <b>A3BR30</b> | 30" Break-Off (Alum. Cap, PVC Pipe, Plastic Base)    | <b>53.60</b> | <b>38.64</b> | <b>32.74</b> | <b>31.59</b> |
| <b>A3BR36</b> | 36" Break-Off (Alum. Cap, PVC Pipe, Plastic Base)    | <b>59.75</b> | <b>45.24</b> | <b>37.44</b> | <b>35.88</b> |

Check out our DEEP-1® magnetic markers for reference points on page 20.

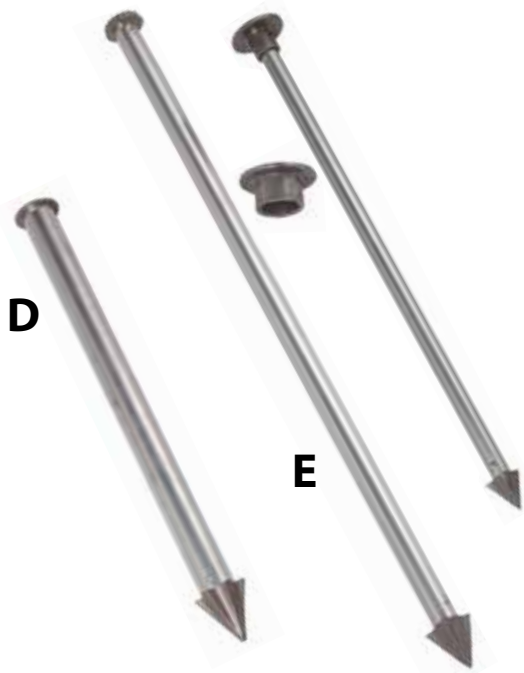

They're  
**Easier** to  
 Install than  
 Concrete  
 Monuments!



*"Our survey crew just installed an Aluminum Drive-in monument with a 3-1/4" cap for a section corner we restored. They said that they want to use them more often, they were utterly amazed at how easy it went into the really rocky ground."*  
 -Washington

**D. WETLANDS MONUMENTS — for stability in looser soil**

These wider, thicker monuments are more stable in wetlands, swamps, riverbanks, and other moist soils, and are **used by the U.S. Fish & Wildlife Service.**

| Item #      | Description                         | 1-10         | 11-24        | 25-99        | 100+         |
|-------------|-------------------------------------|--------------|--------------|--------------|--------------|
| <b>F130</b> | 30" Aluminum Drive-in Cone Monument | <b>55.53</b> | <b>42.75</b> | <b>38.40</b> | <b>37.10</b> |
| <b>F136</b> | 36" Aluminum Drive-in Cone Monument | <b>58.90</b> | <b>48.15</b> | <b>43.12</b> | <b>41.07</b> |

Call for pricing on custom lengths

**E. "G" SERIES OF DRIVE-IN PISTON MONUMENTS — lightweight and quick to install**

The all-aluminum "G" Series monuments are sturdy, lightweight, and much easier to install than concrete bound monuments - in most soils you just drive them in! This makes them perfect for surveys where speed of installation is a main concern. All of the drive-in monuments have magnets installed to aid location with a magnetic locator, and all can be customized to your specifications.

| Item #        | Description                           | 1-10         | 11-24        | 25-99        | 100+         |
|---------------|---------------------------------------|--------------|--------------|--------------|--------------|
| <b>G130</b>   | 30" Aluminum Drive-In Piston          | <b>28.05</b> | <b>22.14</b> | <b>20.09</b> | <b>19.38</b> |
| <b>G136</b>   | 36" Aluminum Drive-In Piston          | <b>32.63</b> | <b>26.53</b> | <b>23.98</b> | <b>22.90</b> |
| <b>G2 CAP</b> | 3 1/4" Aluminum Tap-On Cap for G1     | <b>14.67</b> | <b>10.13</b> | <b>8.06</b>  | <b>7.76</b>  |
| <b>G3250</b>  | 30" Aluminum Drive-In with 2 1/2" Cap | <b>40.09</b> | <b>24.22</b> | <b>20.96</b> | <b>20.22</b> |
| <b>G3325</b>  | 30" Aluminum Drive-In with 3 1/4" Cap | <b>41.99</b> | <b>28.36</b> | <b>24.10</b> | <b>23.24</b> |

The lengths of the monuments shown on pages 4 & 5 are actually 30-34 inches long. The "30 inch" designates the length of the pipe portion of the monument. Our customers generally find that the standard 30-inch length monuments listed meet or exceed their needs. Should custom-made lengths be required for the monuments on your project, please email or fax us for price quotation. If you have any questions, please call us.

**F. SDDR130 DRIVE-IN ROD MONUMENT — pre-installed cap saves time**

30" Driveable 9/16" stainless steel rod with 1-1/2" or 3-1/4" forged bronze cap. Drive directly on the bronze cap with urethane-faced hammer (like our Lixie hammers on page 22). Monument features a welded stainless steel flange that anchors the monument firmly in the ground with a powerful magnet installed on top of rod.

| Item #           | Description                                   | 1-10         | 11-24        | 25-99        | 100+         |
|------------------|---|--------------|--------------|--------------|--------------|
| <b>SDDR130</b>   | 30" Stainless Drive-in Monument w/ 1-1/2" cap | <b>54.33</b> | <b>49.80</b> | <b>45.97</b> | <b>43.94</b> |
| <b>SDDR13035</b> | 30" Stainless Drive-in Monument w/ 3-1/4" cap | <b>90.28</b> | <b>82.76</b> | <b>76.40</b> | <b>73.03</b> |



**Berntsen rod monument installation video...**  
only at [www.berntsen.com](http://www.berntsen.com)

Get the right rod monument for your project. Berntsen's free video in the download section on [www.berntsen.com](http://www.berntsen.com) helps you choose the right monument, explains NGS standards, and includes clear, step-by-step installation instructions with helpful animated sequences.

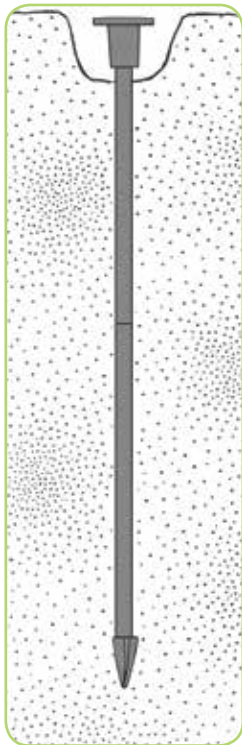

**ROD MONUMENTS — drive until refusal, then cut to fit**

Rod monuments are a series of stainless steel or aluminum rods, usually 3 ft. (915 mm) long, that are driven into the ground either until they reach refusal or when stable ground has been reached.

A domed cap is then tapped straight onto the rod.

The rod can be cut at any stage if refusal is reached.

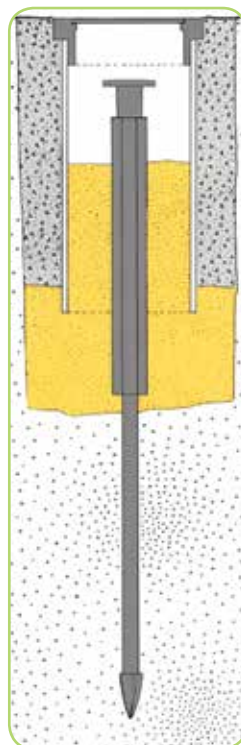

**TOP SECURITY™ ROD MONUMENTS — finned rod stabilizes monument**

These are the same as the rod monuments except that, for the top section, a security rod with 3 aluminum fins is used. This increases the stability of the mark.

All sections of the monument, including the top security section, can be driven straight into the soil, or the top section can be isolated from the top soil as shown above.

The fins of the top security section can be peeled back with vice grips if it is necessary to cut the top section. This enables the cap to be tapped on.

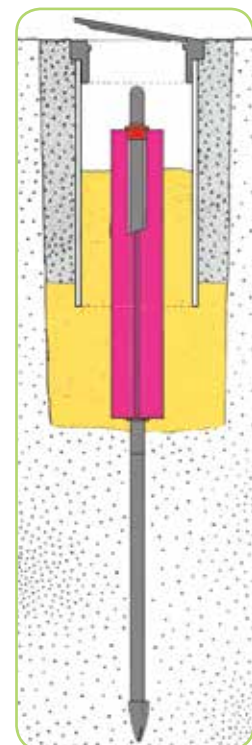

**SLEEVED ROD MONUMENT WITH FLOATING SLEEVE — the best system available for long-term stability**

Where a rod monument is to be used for precise vertical measurements, the top section is encased in a grease-filled plastic sleeve, thus isolating the rod from any movements of the surrounding soil. The sand backfill also helps in this process.

A stainless steel datum point is usually used instead of a domed cap and an access cover would usually be fitted to protect the mark.

## SECTIONAL ROD MONUMENTS FOR CONTROL — preserve the accuracy you work hard to achieve.

Berntsen® sectional rod monuments can be extended to any depth desired for any level of stability and accuracy. All of our sectional rod monuments come with **our exclusive vibration-resistant thread that keeps the rods tightly together while driving**. Our most stable driveable monument and sleeved rod monuments will move less than a millimeter in any direction over several years. Standard rod monuments are usually driven in until they reach refusal or until stable ground has been reached. They are still subject to some movement as surrounding soil swells and shrinks with temperature change.

Top Security™ Rod Monuments are the same as the standard rod monuments, except that 3 aluminum fins are added to the top section to improve stability. These monuments are generally used with a benchmark access cover and backfill, and may be set deeper.

The NGS-style Sleeved Rod Monument with floating sleeve is **our most stable driveable monument**. The grease-filled sleeve allows the soil around the upper part of the monument to expand and contract without affecting the rod's vertical location. When driven to refusal and set as directed, long-term testing has shown that **sleeved rod monuments will move less than a millimeter in any direction over several years**.

Stainless steel rods are available in 9/16" diameter, and aluminum alloy rods are available in 3/4" diameter.

| Item #          | Description                                      | <240                       | 240>                  |
|-----------------|--|----------------------------|-----------------------|
| <b>MSS91604</b> | 9/16" Dia. x 4' Stainless Steel Rod with Thread  | <b>call for price</b>      | <b>call for price</b> |
| <b>MSS12</b>    | 9/16" Stainless Steel Drive Point                | <b>10.35</b>               | <b>10.04</b>          |
| <b>MSSDP1</b>   | Stainless Steel Spherical Datum Point            | <b>12.83</b>               | <b>10.42</b>          |
| <b>MHDDR1</b>   | 3/4" Diameter x 1' Aluminum Rod with Thread      | <b>11.17</b>               | <b>10.38</b>          |
| <b>MHDDR2</b>   | 3/4" Diameter x 2' Aluminum Rod with Thread      | <b>13.05</b>               | <b>11.97</b>          |
| <b>MHDDR3</b>   | 3/4" Diameter x 3' Aluminum Rod with Thread      | <b>9.96</b>                | <b>9.19</b>           |
| <b>MHDDR4</b>   | 3/4" Diameter x 4' Aluminum Rod with Thread      | <b>14.73</b>               | <b>13.49</b>          |
| <b>MHDDR5</b>   | 3/4" Diameter x 5' Aluminum Rod with Thread      | <b>16.27</b>               | <b>12.18</b>          |
| <b>MHDR12</b>   | Spiral Point for 3/4" Rod                        | <b>4.13</b>                | <b>3.82</b>           |
| <b>MHDRDP1</b>  | Aluminum Spherical Datum Point for 3/4" Rod      | <b>10.07</b>               | <b>8.24</b>           |
| <b>M13</b>      | Locking Connector Thread for 5/8", 3/4", & 9/16" | <b>1.29</b>                | <b>1.07</b>           |
| <b>DSLKM</b>    | Disc-Lock Washers for 3/4" Rod (pair)            | <b>1.93</b>                | <b>1.54</b>           |
| <b>RODMAG</b>   | 1/4" Diameter x 1/2" Magnet for Rods             | <b>0.86</b> (Any Quantity) |                       |

**Also Available 5/8" Diameter Aluminum Rod with Thread**

**call for pricing**

Monumentation  
with **High Accuracy**  
(NGS Style)



### TOP SECURITY™ RODS

| Item #        | Description                            | <240         | 240>         |
|---------------|--|--------------|--------------|
| <b>MTSDR3</b> | 3/4" x 3' Top Security Rod with Thread | <b>26.49</b> | <b>21.84</b> |
| <b>MTSDTI</b> | Threaded Insert for 3/4"               | <b>8.32</b>  | <b>7.63</b>  |

### TOP SECURITY™ SLEEVES

| Item #           | Description                                  | <240                   | 240>         |
|------------------|--|------------------------|--------------|
| <b>TSS3</b>      | Top Security Sleeve, 3' (with endcaps)       | <b>15.01</b>           | <b>13.93</b> |
| <b>TSSGREASE</b> | NO-TOX Grease for TSS (Fits Std. Grease Gun) | <b>10.04/Cartridge</b> |              |

### SURVEY CAPS FOR SECTIONAL/TOP SECURITY™ RODS

| Item #          | Description   | 1-24         | 25-99        | 100+         |
|-----------------|---|--------------|--------------|--------------|
| <b>HDR14</b>    | 3 1/4" Domed Cap for 3/4" Rod with Magnet   | <b>8.88</b>  | <b>6.31</b>  | <b>6.04</b>  |
| <b>HDR15</b>    | 2 1/2" Domed Cap for 3/4" Rod with Magnet   | <b>7.64</b>  | <b>5.38</b>  | <b>5.10</b>  |
| <b>RBS325BR</b> | 3 1/4" Bronze Domed Cap for 9/16" Rod with Magnet   | <b>29.68</b> | <b>26.01</b> | <b>24.72</b> |
| <b>MTSD14</b>   | 3 1/4" Domed Aluminum cap for 3/4" Top Security Rod with magnet threaded insert and Disc-Lock washers | <b>15.89</b> | <b>12.25</b> | <b>11.69</b> |

### FLOATING DATUM CAP FOR SLEEVED ROD MONUMENT

The Floating Datum Cap is available in aluminum or bronze and designed to fit over our 3/4" aluminum rod or the 9/16" stainless steel rod. This cap will give you the identification you need without disturbing your accuracy.

| Item #            | Description                                     | 1-24         | 25-99        | 100+         |
|-------------------|---|--------------|--------------|--------------|
| <b>RBD325CH</b>   | 3 1/4" Aluminum Floating Datum Cap for 3/4" Rod | <b>10.59</b> | <b>7.95</b>  | <b>7.62</b>  |
| <b>RBS325CHBR</b> | 3 1/4" Bronze Floating Datum Cap for 9/16" Rod  | <b>30.70</b> | <b>28.07</b> | <b>26.27</b> |





## Berntsen® Access Covers Preserve, Identify, Recover your hard work.

*"I've always been extremely pleased with service and quality of product." -Florida*

### BENCHMARK ACCESS COVERS — two styles, both bond tightly to standard PVC sizes

Our Benchmark Access Covers are intended for use with our Sectional Rod Monuments. They come in 2 styles: NGS style is based on the NGS benchmark with raised hinges and is intended for off-road use, and our BMAC6 covers are heavier duty and made with flush hinges. Covers match the 5" or 6" PVC used to install rod monuments and we sell the perfect adhesive for a tight bond. Tamper-proof screws and setting tool also available. **Order eleven or more and get free stamping on covers!**



Power Adapter

| Item #          | Description                                      | 1-10                             | 11-24        | 25-99        | 100+         |
|-----------------|--|----------------------------------|--------------|--------------|--------------|
| <b>BMAC1</b>    | NGS Style Access Cover for 5" & 6" PVC (Exposed) | <b>55.27</b>                     | <b>53.27</b> | <b>51.81</b> | <b>51.34</b> |
| <b>BMAC6*</b>   | Access Cover for 6" PVC (Recessed Hinge)         | <b>58.19</b>                     | <b>53.90</b> | <b>49.62</b> | <b>47.42</b> |
| <b>TAM3</b>     | Tamper-Proof Tool for BMAC6                      | <b>22.76</b> (Any Quantity)      |              |              |              |
| <b>5PVC</b>     | 5" Schedule 40 PVC Pipe                          | <b>11.57</b> /Ft.                |              |              |              |
| <b>6PVC</b>     | 6" Schedule 40 PVC Pipe                          | <b>16.39</b> /Ft.                |              |              |              |
| <b>UV6800</b>   | Adhesive for BMAC/PVC Pipe (Fits Std. Caulk Gun) | <b>13.25</b> /10.2 oz. Cartridge |              |              |              |
| <b>UV6800-3</b> | Adhesive for BMAC/PVC Pipe 3.7oz. (Squeeze Tube) | <b>8.00</b> each                 |              |              |              |

\*BMAC6 Access Covers available with optional tamper-proof screws; order TAM3 Tamper-proof Tool for access. There's no charge to stamp eleven or more covers.

### DRIVING ADAPTERS — set Berntsen rods faster with custom adapters

Power Driving Adapters and Manual Driving Adapters are made from a special steel that is precision machined and specially hardened for use with the exclusive features of the rods and other components in the Berntsen Rod System. Both are supplied with a hardened M1DPA steel driving pin. Power driving adapter (PDA) will fit Cobra Combi, Pionjär 120 or any machine with a 7/8" hex chuck. The manual driving adapter includes a handle to steady the driver from a safe distance while a hammer is swinging.



Manual Adapter

| Item #          | Description                                       | Each          |
|-----------------|---|---------------|
| <b>MDA</b>      | Manual Driving Adapter                            | <b>91.00</b>  |
| <b>PDAP</b>     | Power Driving Adapter for 7/8" x 4 1/4" Hex Chuck | <b>126.00</b> |
| <b>PDA118X6</b> | Power Driving Adapter for 1 1/8" x 6" Hex Chuck   | <b>134.00</b> |
| <b>M1DPA</b>    | Steel Drive Pin for 5/8", 3/4" or 9/16" Rod       | <b>15.00</b>  |

*"Excellent product with excellent service. Not much to improve on." -Washington*



FENO installation video.... only at [www.berntsen.com](http://www.berntsen.com)  
**Requires No Digging!**

**FENO® DRIVEABLE ANCHORED SURVEY MARKERS** — super-secure, super-fast, no digging

A super-secure monument that requires no digging! The galvanized iron FENO® series is as easy to drive in as any rod monument. When the 6-step process is complete, the marker has 'roots' that anchor it into the ground. The FENO® system comes in 3 lengths - 13.8", 23.6" and 39.4" - and several cap styles. Three tools are needed to set the FENO® markers: a driver that sets the pipe, an extension sleeve that forces the 'roots' through the pipe and into the soil, and a ground plate that prevents the marker from sinking into the ground during installation. Tools sold separately. See our website for complete installation instructions.

| Item #        | Description                                    | 1-10         | 11-24        | 25-99        | 100-249      | 250+         |
|---------------|--|--------------|--------------|--------------|--------------|--------------|
| <b>F50ARA</b> | 2" Aluminum Cap for 350 & 600mm FENO Spike     | <b>12.03</b> | <b>7.20</b>  | <b>5.72</b>  | <b>5.16</b>  | <b>4.98</b>  |
| <b>F50ARB</b> | 2" Aluminum Cap for 1000mm FENO Spike          | <b>12.03</b> | <b>7.20</b>  | <b>5.72</b>  | <b>5.16</b>  | <b>4.98</b>  |
| <b>F50BRA</b> | 2" Bronze Cap for 350 & 600mm FENO Spike       | <b>17.46</b> | <b>14.69</b> | <b>14.16</b> | <b>13.49</b> | <b>13.18</b> |
| <b>F50BRB</b> | 2" Bronze Cap for 1000mm FENO Spike            | <b>17.46</b> | <b>14.69</b> | <b>14.16</b> | <b>13.49</b> | <b>13.18</b> |
| <b>F89ARA</b> | 3-1/2" Aluminum Cap for 350 & 600mm FENO Spike | <b>16.28</b> | <b>10.39</b> | <b>8.93</b>  | <b>8.57</b>  | <b>8.51</b>  |
| <b>F89ARB</b> | 3-1/2" Aluminum Cap for 1000mm FENO Spike      | <b>16.28</b> | <b>10.39</b> | <b>8.93</b>  | <b>8.57</b>  | <b>8.51</b>  |
| <b>F89BRA</b> | 3-1/2" Bronze Cap for 350 & 600 FENO Spike     | <b>38.83</b> | <b>34.09</b> | <b>32.70</b> | <b>30.69</b> | <b>29.97</b> |
| <b>F89BRB</b> | 3-1/2" Bronze Cap for 1000mm FENO Spike        | <b>38.83</b> | <b>34.09</b> | <b>32.70</b> | <b>30.69</b> | <b>29.97</b> |

There's no charge to stamp eleven or more caps. Please see page 32 for stamping layout.

| Item #              | Description   | Any Quantity Each |
|---------------------|---|-------------------|
| <b>F350SPK</b>      | 350 mm (13.8") FENO Mark (spike only - no cap)  | <b>16.00</b>      |
| <b>F600SPK</b>      | 600 mm (23.6") FENO Mark (spike only - no cap)  | <b>18.00</b>      |
| <b>F1000SPK</b>     | 1000 mm (39.4") FENO Mark (spike only - no cap)   | <b>38.00</b>      |
| <b>F350TOOLKIT</b>  | Driver, Extension Sleeve & Ground Plate for 350mm FENO Spike  | <b>70.00</b>      |
| <b>F600TOOLKIT</b>  | Driver, Extension Sleeve & Ground Plate for 600mm FENO Spike.   | <b>76.00</b>      |
| <b>F1000TOOLKIT</b> | Driver, Extension Sleeve & Ground Plate for 1000mm FENO Spike   | <b>130.00</b>     |
| <b>F90</b>          | Polyroc Monument Block for 350 & 600 mm FENO Spike  | <b>12.80</b>      |
| <b>F90NTL</b>       | Natural Rock Monument Block for 350 & 600 mm FENO Spike   | <b>13.00</b>      |
| <b>F110</b>         | Polyroc Monument Block for 1000 mm FENO Spike<br>(Polyroc Blocks are available in Red, White, & Yellow. Please specify color when ordering) | <b>39.00</b>      |
| <b>F350/600SQA</b>  | Square Aluminum Top for 350 & 600mm FENO Spike  | <b>9.50</b>       |
| <b>F1000SQA</b>     | Square Aluminum Top for 1000mm FENO Spike   | <b>20.85</b>      |
| <b>F300PHPLW</b>    | 300mm Square Photogrammetric Plate for 350 & 600 FENO Spike (white)   | <b>1.80</b>       |
| <b>F50PLCAP</b>     | 50mm Diameter Plastic Cap for 350 & 600mm FENO Spike  | <b>1.50</b>       |





"I like the thicker plastic sleeve on the aluminum caps."

-New Mexico



**NEW**  
**SureGrip**  
TECHNOLOGY™

**NEW SUREGRIP™ REBAR CAP WON'T SHIFT OR WOBBLE!**

The insulators in our new rebar caps are now made of a single, thicker piece of plastic. Our improved insulators won't shift or wobble during installation, which means your cap is straight on the rebar.

Berntsen was the first company to recognize that **some dissimilar metals cause corrosion**. Our rebar caps with plastic insulators – first of their kind – solved this problem by placing a barrier between the metals. We've been making our famous rebar caps for more than 40 years now.

While we were at it we also color-coded the insulator – now you can tell at a glance which cap is sized for which rebar.

**A. QUICKSHIP™ FLAT REBAR CAPS — free customization, no corrosion, unbreakable**

Quickship™ caps ship in 2 business days (or less) after your order is received - customized at no charge! Up to 35 characters can be used on one row, giving you ample room to list your license number and business name. The 2" diameter Flat Caps can also be stamped (using one of our stamp sets – see page 23) for customizing in the field. The unique plastic insulator allows tight, quick placement with no fear of corrosion caused by dissimilar metals, and the forged aluminum construction means that your caps will not break.

| Item #         | Description (with 1 row of 35 characters) | 100-249     | 250-499     | 500+        |
|----------------|---|-------------|-------------|-------------|
| <b>QSH3200</b> | 2" QuickShip Flat Cap for 3/8" Rebar      | <b>2.80</b> | <b>2.70</b> | <b>2.60</b> |
| <b>QSH4200</b> | 2" QuickShip Flat Cap for 1/2" Rebar      | <b>2.80</b> | <b>2.70</b> | <b>2.60</b> |
| <b>QSD5200</b> | 2" QuickShip Flat Cap for 5/8" Rebar      | <b>2.80</b> | <b>2.70</b> | <b>2.60</b> |
| <b>QSX6200</b> | 2" QuickShip Flat Cap for 3/4" Rebar      | <b>3.35</b> | <b>3.15</b> | <b>3.00</b> |
| <b>QSX7200</b> | 2" QuickShip Flat Cap for 7/8" Rebar      | <b>3.35</b> | <b>3.15</b> | <b>3.00</b> |
| <b>QSX8200</b> | 2" QuickShip Flat Cap for 1" Rebar        | <b>3.35</b> | <b>3.15</b> | <b>3.00</b> |

Minimum quantities of 100. Limit 35 characters on one row maximum.



**Standard Center Designs**

No Center Design Needed

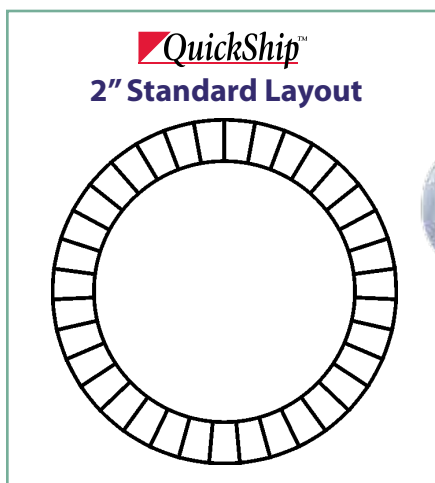

# Customize Online! at [www.berntsen.com](http://www.berntsen.com)



## B. REBAR CAPS - DOMED OR FLAT TOP — more sizes, to fit more information

Berntsen® Standard Flat or Domed Top rebar caps come in more sizes than our QuickShip™ caps and can be imprinted with more information. The SureGrip™ plastic insulator and forged aluminum construction are the same as the QuickShip™ caps.

### CAPS TO FIT 3/8" REBAR - Red SureGrip™

| Item #           | Description                                | 1-24         | 25-99        | 100-249      | 250-499      | 500+         |
|------------------|--|--------------|--------------|--------------|--------------|--------------|
| <b>FTH3150</b>   | 1 1/2" Flat Cap for 3/8" Rebar (Aluminum)  | <b>5.85</b>  | <b>4.18</b>  | <b>3.41</b>  | <b>3.30</b>  | <b>2.47</b>  |
| <b>FTH3200</b>   | 2" Flat Cap for 3/8" Rebar (Aluminum)      | <b>5.96</b>  | <b>4.33</b>  | <b>3.73</b>  | <b>3.46</b>  | <b>2.74</b>  |
| <b>FTH3200BR</b> | 2" Flat Cap for 3/8" Rebar (Bronze)        | <b>24.98</b> | <b>23.46</b> | <b>22.45</b> | <b>21.58</b> | <b>20.09</b> |
| <b>RBH3250</b>   | 2 1/2" Domed Cap for 3/8" Rebar (Aluminum) | <b>8.17</b>  | <b>4.79</b>  | <b>4.27</b>  | <b>3.99</b>  | <b>3.46</b>  |
| <b>RBH3325</b>   | 3 1/4" Domed Cap for 3/8" Rebar (Aluminum) | <b>8.41</b>  | <b>5.36</b>  | <b>5.00</b>  | <b>4.68</b>  | <b>4.17</b>  |
| <b>RBH3325BR</b> | 3 1/4" Domed Cap for 3/8" Rebar (Bronze)   | <b>31.42</b> | <b>29.31</b> | <b>28.07</b> | <b>27.30</b> | <b>25.73</b> |

### CAPS TO FIT 1/2" REBAR - Yellow SureGrip™

|                  |  |              |              |              |              |              |
|------------------|--|--------------|--------------|--------------|--------------|--------------|
| <b>FTH4150</b>   | 1 1/2" Flat Cap for 1/2" Rebar (Aluminum)  | <b>5.85</b>  | <b>4.18</b>  | <b>3.41</b>  | <b>3.30</b>  | <b>2.47</b>  |
| <b>FTH4200</b>   | 2" Flat Cap for 1/2" Rebar (Aluminum)      | <b>5.96</b>  | <b>4.33</b>  | <b>3.73</b>  | <b>3.46</b>  | <b>2.74</b>  |
| <b>FTH4200BR</b> | 2" Flat Cap for 1/2" Rebar (Bronze)        | <b>24.98</b> | <b>23.46</b> | <b>22.45</b> | <b>21.58</b> | <b>20.09</b> |
| <b>RBH4250</b>   | 2 1/2" Domed Cap for 1/2" Rebar (Aluminum) | <b>8.17</b>  | <b>4.79</b>  | <b>4.27</b>  | <b>3.99</b>  | <b>3.46</b>  |
| <b>RBH4325</b>   | 3 1/4" Domed Cap for 1/2" Rebar (Aluminum) | <b>8.41</b>  | <b>5.36</b>  | <b>5.00</b>  | <b>4.68</b>  | <b>4.17</b>  |
| <b>RBH4325BR</b> | 3 1/4" Domed Cap for 1/2" Rebar (Bronze)   | <b>31.42</b> | <b>29.31</b> | <b>28.07</b> | <b>27.30</b> | <b>25.73</b> |

### CAPS TO FIT 5/8" REBAR - Pink SureGrip™

|                  |  |              |              |              |              |              |
|------------------|--|--------------|--------------|--------------|--------------|--------------|
| <b>FTD5150</b>   | 1 1/2" Flat Cap for 5/8" Rebar (Aluminum)  | <b>5.85</b>  | <b>4.18</b>  | <b>3.41</b>  | <b>3.30</b>  | <b>2.47</b>  |
| <b>FTD5200</b>   | 2" Flat Cap for 5/8" Rebar (Aluminum)      | <b>5.96</b>  | <b>4.33</b>  | <b>3.73</b>  | <b>3.46</b>  | <b>2.74</b>  |
| <b>FTD5200BR</b> | 2" Flat Cap for 5/8" Rebar (Bronze)        | <b>24.98</b> | <b>23.46</b> | <b>22.45</b> | <b>21.58</b> | <b>20.09</b> |
| <b>RBD5250</b>   | 2 1/2" Domed Cap for 5/8" Rebar (Aluminum) | <b>8.17</b>  | <b>4.79</b>  | <b>4.27</b>  | <b>3.99</b>  | <b>3.46</b>  |
| <b>RBD5325</b>   | 3 1/4" Domed Cap for 5/8" Rebar (Aluminum) | <b>8.41</b>  | <b>5.36</b>  | <b>5.00</b>  | <b>4.68</b>  | <b>4.17</b>  |
| <b>RBD5325BR</b> | 3 1/4" Domed Cap for 5/8" Rebar (Bronze)   | <b>31.42</b> | <b>29.31</b> | <b>28.07</b> | <b>27.30</b> | <b>25.73</b> |

### CAPS TO FIT 3/4" REBAR - Orange SureGrip™

|                  |  |              |              |              |              |              |
|------------------|--|--------------|--------------|--------------|--------------|--------------|
| <b>FTX6200</b>   | 2" Flat Cap for 3/4" Rebar (Aluminum)      | <b>6.39</b>  | <b>4.31</b>  | <b>3.84</b>  | <b>3.58</b>  | <b>3.19</b>  |
| <b>RBX6250</b>   | 2 1/2" Domed Cap for 3/4" Rebar (Aluminum) | <b>8.11</b>  | <b>4.51</b>  | <b>4.36</b>  | <b>4.12</b>  | <b>3.49</b>  |
| <b>RBX6325</b>   | 3 1/4" Domed Cap for 3/4" Rebar (Aluminum) | <b>8.66</b>  | <b>5.09</b>  | <b>4.89</b>  | <b>4.67</b>  | <b>4.21</b>  |
| <b>RBX6325BR</b> | 3 1/4" Domed Cap for 3/4" Rebar (Bronze)   | <b>40.74</b> | <b>35.79</b> | <b>34.82</b> | <b>33.11</b> | <b>31.16</b> |

### CAPS TO FIT 7/8" REBAR - Green SureGrip™

|                  |  |              |              |              |              |              |
|------------------|--|--------------|--------------|--------------|--------------|--------------|
| <b>FTX7200</b>   | 2" Flat Cap for 7/8" Rebar (Aluminum)      | <b>6.39</b>  | <b>4.31</b>  | <b>3.84</b>  | <b>3.58</b>  | <b>3.19</b>  |
| <b>RBX7250</b>   | 2 1/2" Domed Cap for 7/8" Rebar (Aluminum) | <b>8.11</b>  | <b>4.51</b>  | <b>4.36</b>  | <b>4.12</b>  | <b>3.49</b>  |
| <b>RBX7325</b>   | 3 1/4" Domed Cap for 7/8" Rebar (Aluminum) | <b>8.66</b>  | <b>5.09</b>  | <b>4.89</b>  | <b>4.67</b>  | <b>4.21</b>  |
| <b>RBX7325BR</b> | 3 1/4" Domed Cap for 7/8" Rebar (Bronze)   | <b>40.74</b> | <b>35.79</b> | <b>34.82</b> | <b>33.11</b> | <b>31.16</b> |

### CAPS TO FIT 1" REBAR - Red SureGrip™

|                |  |             |             |             |             |             |
|----------------|--|-------------|-------------|-------------|-------------|-------------|
| <b>FTX8200</b> | 2" Flat cap for 1" Rebar (Aluminum)      | <b>6.39</b> | <b>4.31</b> | <b>3.84</b> | <b>3.58</b> | <b>3.19</b> |
| <b>RBX8250</b> | 2 1/2" Domed Cap for 1" Rebar (Aluminum) | <b>8.11</b> | <b>4.51</b> | <b>4.36</b> | <b>4.12</b> | <b>3.49</b> |
| <b>RBX8325</b> | 3 1/4" Domed Cap for 1" Rebar (Aluminum) | <b>8.66</b> | <b>5.09</b> | <b>4.89</b> | <b>4.67</b> | <b>4.21</b> |

### PIPE CAPS for Schedule 40 Pipe

|               |   |             |             |             |             |             |
|---------------|---|-------------|-------------|-------------|-------------|-------------|
| <b>PC6200</b> | 2" Flat Cap for 3/4" ID Pipe (Aluminum) | <b>6.23</b> | <b>4.20</b> | <b>3.93</b> | <b>3.66</b> | <b>2.89</b> |
| <b>PC8200</b> | 2" Flat Cap for 1" ID Pipe (Aluminum)   | <b>6.27</b> | <b>5.08</b> | <b>4.41</b> | <b>3.73</b> | <b>3.17</b> |

There's no charge to stamp eleven or more caps. Please see page 32 for stamping layout.  
SETUP charge for stamping less than eleven \$35.00  
Rebar drivers \$55.50 (on page 22 of SurveyLog)



*"Speed of delivery... WOW! Have been a long-term customer—very satisfied!"*  
-Virginia

# You Need More Printing, More Sizes, More Colors?

## ...You Need Morasse!

Rebar & Pipe Caps

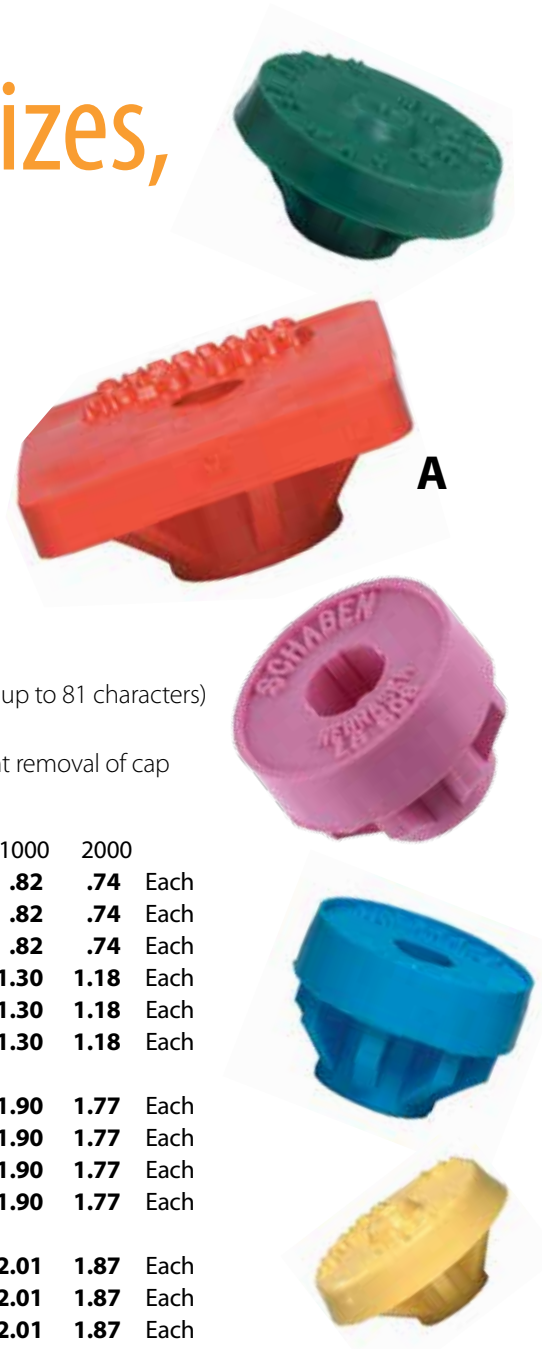

### A. MORASSE PLASTIC SURVEY CAPS — your name and number free!

- Available with your name & number at no extra cost
- Easy to read raised letters
- High quality UV stabilized polyethylene to protect against fading
- Color is throughout marker to provide longer life
- Can be field stamped with steel stamp set
- More durable than other plastic caps - More characters available (smallest size holds up to 81 characters)
- Available with closed center (F style) or open center
- Unique open center allows bar to 'mushroom' over cap during driving - helps prevent removal of cap
- Easy to install and difficult to remove

| Item #                | Description  | 200  | 500  | 1000 | 2000 |      |
|-----------------------|--|------|------|------|------|------|
| <b>G41 &amp; G41F</b> | MORASSE 1 3/4" Diameter Plastic Cap for 3/8" Rebar | .97  | .91  | .82  | .74  | Each |
| <b>G42 &amp; G42F</b> | MORASSE 1 3/4" Diameter Plastic Cap for 1/2" Rebar | .97  | .91  | .82  | .74  | Each |
| <b>G43 &amp; G43F</b> | MORASSE 1 3/4" Diameter Plastic Cap for 5/8" Rebar | .97  | .91  | .82  | .74  | Each |
| <b>P41 &amp; P41F</b> | MORASSE 2 3/8" Diameter Plastic Cap for 3/8" Rebar | 1.53 | 1.39 | 1.30 | 1.18 | Each |
| <b>P42 &amp; P42F</b> | MORASSE 2 3/8" Diameter Plastic Cap for 1/2" Rebar | 1.53 | 1.39 | 1.30 | 1.18 | Each |
| <b>P43 &amp; P43F</b> | MORASSE 2 3/8" Diameter Plastic Cap for 5/8" Rebar | 1.53 | 1.39 | 1.30 | 1.18 | Each |
| <b>M41 &amp; M41F</b> | MORASSE 2 3/4" Diameter Plastic Cap for 3/8" Rebar | 2.15 | 2.02 | 1.90 | 1.77 | Each |
| <b>M42 &amp; M42F</b> | MORASSE 2 3/4" Diameter Plastic Cap for 1/2" Rebar | 2.15 | 2.02 | 1.90 | 1.77 | Each |
| <b>M43 &amp; M43F</b> | MORASSE 2 3/4" Diameter Plastic Cap for 5/8" Rebar | 2.15 | 2.02 | 1.90 | 1.77 | Each |
| <b>M44 &amp; M44F</b> | MORASSE 2 3/4" Diameter Plastic Cap for 3/4" Rebar | 2.15 | 2.02 | 1.90 | 1.77 | Each |
| <b>C41 &amp; C41F</b> | MORASSE 2 3/4" Square Plastic Cap for 3/8" Rebar   | 2.25 | 2.12 | 2.01 | 1.87 | Each |
| <b>C42 &amp; C42F</b> | MORASSE 2 3/4" Square Plastic Cap for 1/2" Rebar   | 2.25 | 2.12 | 2.01 | 1.87 | Each |
| <b>C43 &amp; C43F</b> | MORASSE 2 3/4" Square Plastic Cap for 5/8" Rebar   | 2.25 | 2.12 | 2.01 | 1.87 | Each |
| <b>C44 &amp; C44F</b> | MORASSE 2 3/4" Square Plastic Cap for 3/4" Rebar   | 2.25 | 2.12 | 2.01 | 1.87 | Each |

Available in Bright Orange, Red/Orange, Blue, Yellow, Green, and Pink. "F" designates closed center • Minimum Order: 200  
See page 33 for stamping layout.

### B. MORASSE CAPS - NOW IN STOCK

The G43F (closed center) Morasse cap for 5/8" rebar, is now in stock with four of the most requested imprints. Survey Marker (yellow), Boundary Marker (pink), Control Point (orange) and Traverse Point (red/orange). Minimum order is 50 caps ready for immediate shipment.

| Item #        | Description   | 50 + |
|---------------|---|------|
| <b>G43FBM</b> | Morasse 1 3/4" Cap for 5/8" Rebar Orange Boundary Marker    | 1.30 |
| <b>G43FCP</b> | Morasse 1 3/4" Cap for 5/8" Rebar Orange Control Point      | 1.30 |
| <b>G43FSM</b> | Morasse 1 3/4" Cap for 5/8" Rebar Yellow Survey Marker      | 1.30 |
| <b>G43FTP</b> | Morasse 1 3/4" Cap for 5/8" Rebar Red/Orange Traverse Point | 1.30 |

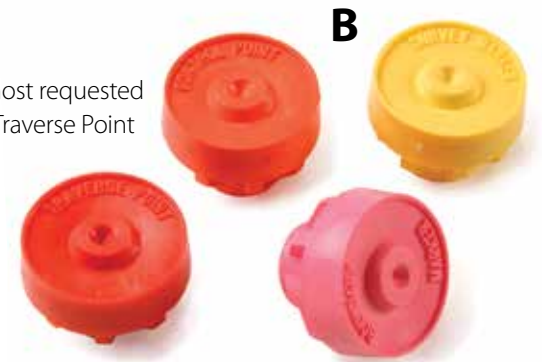

# Berntsen Plastic Caps

are now available in hot stamped black lettering



Rebar & Pipe Caps

## A. BERNTSEN BLACK-FILLED PLASTIC SURVEY CAPS — easy to read and easy to install

Berntsen plastic caps with black lettering come in a wide array of colors, are easy to read in the field and easy to tap on rebar and pipe for permanent identification.

*"Best customer service of all my suppliers!"*

*-Texas*

| Item #         | Plastic Cap For:          | 200+             | 500+             | 1000+            |
|----------------|---------------------------|------------------|------------------|------------------|
| <b>BFPCAP3</b> | 3/8" Rebar & 1/2" ID Pipe | <b>48.00/100</b> | <b>43.00/100</b> | <b>40.00/100</b> |
| <b>BFPCAP4</b> | 1/2" Rebar & 3/4" ID Pipe | <b>49.00/100</b> | <b>46.00/100</b> | <b>42.00/100</b> |
| <b>BFPCAP5</b> | 5/8" Rebar & 1" ID Pipe   | <b>51.00/100</b> | <b>47.00/100</b> | <b>43.00/100</b> |
| <b>BFPCAP6</b> | 3/4" Rebar                | <b>52.00/100</b> | <b>49.00/100</b> | <b>46.00/100</b> |

Minimum order: 200. Prices are per 100. Available in Yellow, Red, Orange, and Pink. Other colors available upon request.

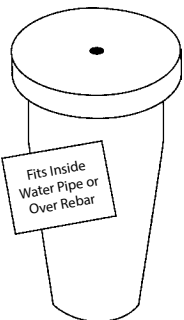

### Standard Layout for BERNTSEN Caps

Lettering is straight across only. All come with center "hole".

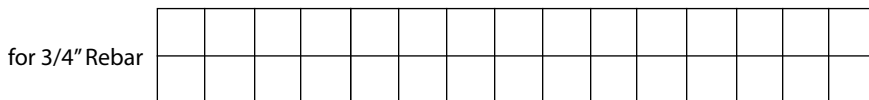
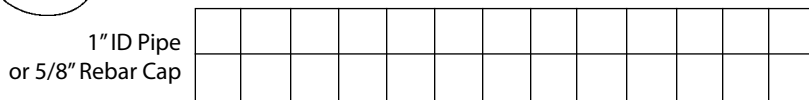
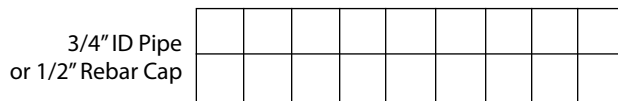

### BERNTSEN Color Choices

Yellow  Red  Orange  Pink

## B. PERMAMARK® PLASTIC SURVEY CAPS\* — fade-resistant and free customization

The PERMAMARK® is a fast, economical, and long lasting way to personally claim the corners you set. The colors resist fading from UV exposure, and the entire line can be customized with your name and license number at no extra cost.

| Item #          | Permamark Cap For:        | 200+             | 500+             | 1000+            |
|-----------------|---------------------------|------------------|------------------|------------------|
| <b>PERM3000</b> | 3/8" Rebar & 1/2" ID Pipe | <b>42.00/100</b> | <b>38.00/100</b> | <b>35.00/100</b> |
| <b>PERM4000</b> | 1/2" Rebar & 3/4" ID Pipe | <b>43.00/100</b> | <b>40.00/100</b> | <b>37.00/100</b> |
| <b>PERM5000</b> | 5/8" Rebar & 1" ID Pipe   | <b>46.00/100</b> | <b>41.00/100</b> | <b>38.00/100</b> |
| <b>PERM6000</b> | 3/4" Rebar                | <b>47.00/100</b> | <b>43.00/100</b> | <b>40.00/100</b> |

Minimum order: 200. Prices are per 100. Available in Yellow, Red, Orange & Pink (Pink is only available in 4000 & 5000 sizes). Yellow will be ordered unless otherwise specified. See page 32 for stamping layout.

\* Stamping on PERMAMARK is recessed but NOT black-filled.



# Domed Concrete Markers WITH IMPRINT... Ships in DAYS

## CONCRETE MARKERS — notched, flared stems hold tight in concrete

### BERNTSEN® CONCRETE MARKERS & ROCK TABLETS

Berntsen® aluminum & bronze CD style concrete markers have a 3/4" diameter x 2" long notched stem to hold firmly into concrete or rock. The CD series is only available in 2" diameter tops. Berntsen's aluminum and bronze C style markers are the equivalent of the Corps of Engineers Type 1 disc, and can be customized with your imprint. The C style is an orbital forged marker made with a split-style flared solid stem.

The RT35 resembles the 3-1/2" C style models, but is made with 4 flared legs for better resistance, which makes this marker more vandal proof.

A magnet can be attached (CAPMAG) to the underside of all our concrete markers, **upon request**, at a small additional cost. This will allow easy detection with a magnetic locator.

### ALUMINUM CONCRETE MARKERS - COLD FORGED 6000 SERIES ALUMINUM

| Item #       | Description                             | 1-24         | 25-99        | 100-249      | 250+         |
|--------------|---|--------------|--------------|--------------|--------------|
| <b>CD2</b>   | 2" Domed Concrete Marker (Aluminum)     | <b>6.72</b>  | <b>5.60</b>  | <b>4.39</b>  | <b>3.73</b>  |
| <b>C25D</b>  | 2 1/2" Domed Concrete Marker (Aluminum) | <b>13.12</b> | <b>11.85</b> | <b>11.10</b> | <b>10.41</b> |
| <b>C35D</b>  | 3 1/2" Domed Concrete Marker (Aluminum) | <b>12.50</b> | <b>12.22</b> | <b>11.81</b> | <b>11.33</b> |
| <b>C35F</b>  | 3 1/2" Flat Concrete Marker (Aluminum)  | <b>19.02</b> | <b>16.83</b> | <b>15.22</b> | <b>14.39</b> |
| <b>C4D</b>   | 4" Domed Concrete Marker (Aluminum)     | <b>15.90</b> | <b>14.40</b> | <b>12.39</b> | <b>11.66</b> |
| <b>RT35D</b> | 3 1/2" Domed Rock Tablet (Aluminum)     | <b>17.43</b> | <b>16.14</b> | <b>14.70</b> | <b>13.54</b> |
| <b>RT35F</b> | 3 1/2" Flat Rock Tablet (Aluminum)      | <b>20.26</b> | <b>18.93</b> | <b>17.95</b> | <b>17.60</b> |

### BRONZE CONCRETE MARKERS - ORBITAL FORGED SILICON BRONZE (LEAD FREE)

| Item #        | Description                           | 1-10         | 11-24        | 25-99        | 100+         |
|---------------|---------------------------------------|--------------|--------------|--------------|--------------|
| <b>CD2B</b>   | 2" Domed Concrete Marker (Bronze)     | <b>14.29</b> | <b>12.90</b> | <b>10.93</b> | <b>9.98</b>  |
| <b>C25DB</b>  | 2 1/2" Domed Concrete Marker (Bronze) | <b>32.56</b> | <b>29.30</b> | <b>27.40</b> | <b>26.05</b> |
| <b>C35DB</b>  | 3 1/2" Domed Concrete Marker (Bronze) | <b>43.89</b> | <b>39.76</b> | <b>35.79</b> | <b>33.46</b> |
| <b>C35FB</b>  | 3 1/2" Flat Concrete Marker (Bronze)  | <b>49.75</b> | <b>44.06</b> | <b>40.05</b> | <b>37.33</b> |
| <b>C4DB</b>   | 4" Domed Concrete Marker (Bronze)     | <b>52.66</b> | <b>50.00</b> | <b>45.06</b> | <b>41.18</b> |
| <b>RT35DB</b> | 3 1/2" Domed Rock Tablet (Bronze)     | <b>47.15</b> | <b>43.94</b> | <b>39.91</b> | <b>36.92</b> |
| <b>RT35FB</b> | 3 1/2" Flat Rock Tablet (Bronze)      | <b>50.81</b> | <b>48.15</b> | <b>42.80</b> | <b>41.02</b> |

**CAPMAG** 1/2" diameter x 1/4" Ceramic Magnet for Markers **0.49** (Any Quantity)

There's no charge to stamp eleven or more markers. Please see page 32 for stamping layout.

## LEVELING MARKERS — works with level rods and standard prism poles

### BERNTSEN® CD2L LEVELING MARK SERIES

Perfect for situations requiring horizontal and vertical location, the CD2L features a raised datum point with a small center dimple that works well with flat bottomed leveling rods or standard prism rods. Intended for use in concrete, the CD2L is 2" in diameter and can be customized with a double row of lettering around the perimeter. Available in aluminum alloy or bronze.

| Item #       | Description                                  | 1-24         | 25-99        | 100-249      | 250+         |
|--------------|--|--------------|--------------|--------------|--------------|
| <b>CD2L</b>  | 2" Leveling Mark with Datum Point (Aluminum) | <b>7.60</b>  | <b>6.33</b>  | <b>5.20</b>  | <b>4.84</b>  |
| <b>CD2BL</b> | 2" Leveling Mark with Datum Point (Bronze)   | <b>14.65</b> | <b>13.12</b> | <b>11.85</b> | <b>10.76</b> |

There's no charge to stamp eleven or more markers. Please see page 32 for stamping layout.

Concrete Markers



# NEW! Countersink Drill Bits

## Available in ALL FOUR SIZES of Berntsen® Concrete Markers



Countersink Drill Bits

**Introducing Berntsen's exclusive series of countersink drill bits – a new way to set perfectly recessed concrete markers fast!**

### A. SDS-MAX COUNTERSINK DRILL BITS

| Item#   | Description                            | Price  |
|---------|--|--------|
| CD2DRLM | 2" Countersink Drill Bit (3-piece)     | 277.00 |
| C25DRLM | 2-1/2" Countersink Drill Bit (3-piece) | 308.00 |
| C35DRLM | 3-1/2" Countersink Drill Bit (3-piece) | 386.00 |
| C4DRLM  | 4" Countersink Drill Bit (3-piece)     | 411.00 |

*(Works w/ Corded SDS-Max drill, see page 16)*

These drill bits countersink top of marker only (not the stem). We suggest a 1" drill bit to create the stem hole.

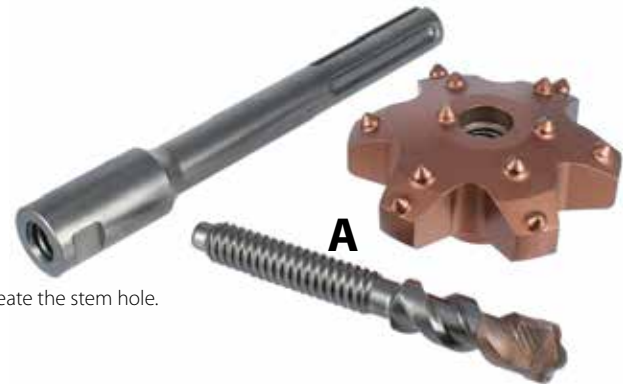

### B. SDS-PLUS COUNTERSINK DRILL BITS

| Item#   | Description                            | Price  |
|---------|--|--------|
| CD2DRLP | 2" Countersink Drill Bit (3-piece)     | 277.00 |
| C25DRLP | 2-1/2" Countersink Drill Bit (3-piece) | 308.00 |
| C35DRLP | 3-1/2" Countersink Drill Bit (3-piece) | 386.00 |
| C4DRLP  | 4" Countersink Drill Bit (3-piece)     | 411.00 |
| HA1020  | Adapter, Spline to SDS-Plus Chuck      | 89.50  |

*(Works with 36-Volt hammer drill, see page 16)*



### C. SPLINE CHUCK COUNTERSINK DRILL BITS

| Item#   | Description                            | Price  |
|---------|--|--------|
| CD2DRLS | 2" Countersink Drill Bit (3-piece)     | 277.00 |
| C25DRLS | 2-1/2" Countersink Drill Bit (3-piece) | 308.00 |
| C35DRLS | 3-1/2" Countersink Drill Bit (3-piece) | 386.00 |
| C4DRLS  | 4" Countersink Drill Bit (3-piece)     | 411.00 |

These drill bits countersink top of marker only (not the stem). We suggest a 1" drill bit to create the stem hole.

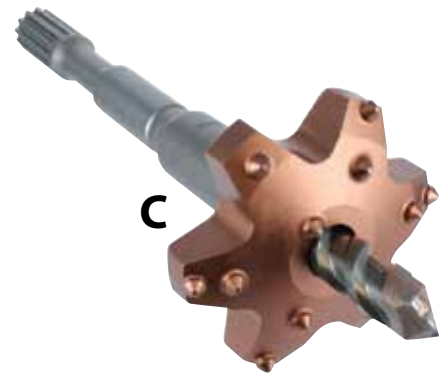

*"The countersink drill bit we purchased to install Berntsen concrete markers works PERFECTLY! We scheduled 2 days labor and ended up only using about 5 hours. It's very handy, still in great shape and paid for itself the first time we used it."*

*- Jake Teegarden, Vasconcelles Engineering Corp., Springfield, IL*

## DRYLOK® — easy-to-use cement, just add water!

### D. DRYLOK FAST PLUG

DRYLOK Fast Plug is simple to use – just add clean, room temperature water to this hydraulic cement. DRYLOK will set up in just minutes, depending on conditions. Comes in 4 lb. and 10 lb. cans.

| Item #       | Description                   | Price |
|--------------|-------------------------------|-------|
| FAST PLUG    | DRYLOK Fast Plug (4 lb. can)  | 9.25  |
| FAST PLUG 10 | DRYLOK Fast Plug (10 lb. can) | 27.50 |



# Bosch®

## Rotary Hammer Drills



### BOSCH 36-VOLT SDS-PLUS CORDLESS ROTARY HAMMER HITS HARDER AND DRILLS FASTER! CHARGE BATTERIES FASTER! WORK FASTER!

Bosch's new 36-volt cordless rotary hammer drill is the fastest, hardest hitting cordless rotary hammer drill available – **it drills 50% faster than the nearest competitor** and packs 2.2 ft.-lbs. of impact force! Litheon 36V batteries charge to 80% of capacity in just 30 minutes, and last longer than other 36V batteries. The tool-free chuck is easy to use, protects from dust, allows 36 chisel positions, and locks bits in securely for 100% power transfer. End charging guesswork with battery temperature and charge indicator built into the included charger. And, of course, you get all the other great Bosch features, like comfortable ergonomically cushioned grips, integral clutch, variable speed trigger for accuracy, and three-mode selector that switches between rotary hammer, rotary only, and hammer only. The complete system includes carrying case, auxiliary handle, depth gauge, charger, and two 36-volt batteries.

| Item #           | Description                     |               |
|------------------|---------------------------------|---------------|
| <b>BOSCH 36V</b> | 1" SDS-Plus Rotary Hammer Drill | <b>800.00</b> |

### BOSCH 1-5/8" SDS-MAX CORDED ROTARY HAMMER — Best performing rotary hammer in its class

Unmatched Power-to-Weight Ratio – 13 Amps, 8.1 ft.-lbs. impact energy. It's made by Bosch, the world's number one maker of rotary hammers. Weighing less than 15 lbs., this hammer drill packs a punch. **The one-hand, tool free SDS-Max® system makes changing bits easier than ever while maximizing jobsite productivity.** This drill system includes patented cord turret to reduce cord wear, 360° auxiliary side handle and carrying case.



| Item #             | Description                              |               |
|--------------------|--|---------------|
| <b>BHC11264EVS</b> | Bosch 1-5/8" SDS-Max Rotary Hammer Drill | <b>740.00</b> |

### SDS-MAX DRILL BITS

| Item #            | Description                     |              |
|-------------------|---------------------------------|--------------|
| <b>SM-420-420</b> | SDS-Max Drill Bit 1" x 8" x 13" | <b>44.70</b> |



### SDS-PLUS DRILL BITS

| Item #         | Description                         |              |
|----------------|-------------------------------------|--------------|
| <b>BHC2122</b> | SDS-Plus Drill Bit 3/4" x 6" x 8"   | <b>38.00</b> |
| <b>BHC2124</b> | SDS-Plus Drill Bit 3/4" x 10" x 12" | <b>40.30</b> |
| <b>BHC2081</b> | SDS-Plus Drill Bit 1/2" x 4" x 6"   | <b>11.30</b> |
| <b>BHC2084</b> | SDS-Plus Drill Bit 1/2" x 10" x 12" | <b>21.50</b> |
| <b>BHC2102</b> | SDS-Plus Drill Bit 5/8" x 6" x 8"   | <b>21.50</b> |
| <b>BHC2104</b> | SDS-Plus Drill Bit 5/8" x 10" x 12" | <b>32.85</b> |
| <b>BHC2142</b> | SDS-Plus Drill Bit 7/8" x 6" x 8"   | <b>49.30</b> |
| <b>BHC2144</b> | SDS-Plus Drill Bit 7/8" x 10" x 12" | <b>51.00</b> |

*"You guys are fantastic.  
Berntsen is a superb supplier."*

*—Tennessee*

### DRILL ACCESSORIES

| Item #        | Description                       |               |
|---------------|-----------------------------------|---------------|
| <b>HA1020</b> | Adapter, Spline to SDS-Plus Chuck | <b>89.50</b>  |
| <b>T1854</b>  | Blow-out Bulb                     | <b>22.00</b>  |
| <b>BAT836</b> | 36-Volt Battery                   | <b>299.00</b> |



BOSCH blow-out bulb — removes debris from drill hole

# Markers that install in Minutes! Virtually No Trip Hazard

## CONCRETE MARKERS

### A. BP MARKERS — our fastest-installing concrete marker

Berntsen® BP series copper markers install faster than any other concrete marker we sell. Just drill a hole with our countersink drill bit (sold separately), insert the included expansion plug, and tap in the BP marker. The BP is secure without epoxy or grout and will be flush with the concrete surface, not raised.

BP Markers have a 1.17" diameter face and are available in 3 styles. The BP1 comes with the words "Survey Mark" set slightly below the surface rim and center punch area. The BP1P is similar, except that the choice of lettering (up to 14 characters) is up to you. And the BP2, also customizable with up to 14 characters, is flat on top with no recess.

| Item #        | Description   | 25-99       | 100-249     | 250-499     | 500+        |
|---------------|---|-------------|-------------|-------------|-------------|
| <b>BP1-SM</b> | BP Marker w/Anchoring Plug<br>Imprinted with "SURVEY MARK"  | <b>2.42</b> | <b>2.17</b> | <b>2.02</b> | <b>1.86</b> |
| <b>BP1P</b>   | BP Marker w/Anchoring Plug<br>Custom imprint with up to 14 characters                               | <b>3.19</b> | <b>3.01</b> | <b>2.73</b> | <b>2.52</b> |
| <b>BP2</b>    | BP Marker w/Anchoring Plug<br>No recessed center punch -<br>Custom imprint with up to 14 characters | <b>3.19</b> | <b>3.01</b> | <b>2.73</b> | <b>2.52</b> |

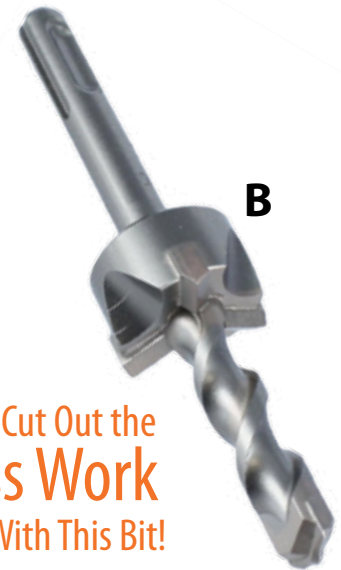
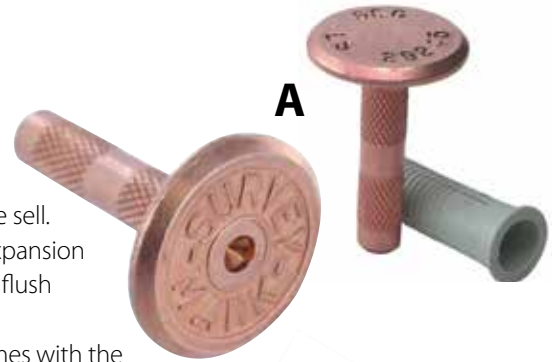

Cut Out the  
Guess Work  
With This Bit!

There's no charge to stamp 25 or more markers. Please see page 32 for stamping layout.

### B. BP1/BP2 COUNTERSINK DRILL BIT — drill stem hole and cap recess in one pass

This bit is specially designed as an installation tool for the BP series markers. It is the correct width and depth for the BP shank and is fitted with a set of teeth that grind out a recessed area perfectly sized to accept the BP's flat face. The monument ends up flush with the concrete surface. This bit works with hammer drills with a SDS-Plus chuck.

| Item #        | Description                       | Each          |
|---------------|-----------------------------------|---------------|
| <b>BPMDRL</b> | SDS-Plus Countersink Drill Bit    | <b>118.50</b> |
| <b>HA1020</b> | Adapter, Spline to SDS-Plus Chuck | <b>89.50</b>  |

## CONCRETE MONUMENTS/BOUNDS — let us pour the concrete for you!

### C. PRE-CAST CONCRETE MONUMENTS — Berntsen can custom design monuments

Your customized Berntsen aluminum or bronze concrete markers can now be set directly into a rebar-reinforced concrete monument and shipped on pallets to your door. No more pouring concrete on-site.

Several standard-size monuments are available, or Berntsen can custom design monuments from your blueprints, drawings and specifications. Contact customer service for details.

| Item #          | Description                             | 11-24         | 25-49         | 50+           |
|-----------------|---|---------------|---------------|---------------|
| <b>CM4X4X24</b> | 4" x 4" x 24" Concrete Survey Monument* | <b>38.00</b>  | <b>35.00</b>  | <b>32.00</b>  |
| <b>CM4X4X30</b> | 4" x 4" x 30" Concrete Survey Monument* | <b>40.00</b>  | <b>37.00</b>  | <b>33.00</b>  |
| <b>CM4X5X30</b> | 4" x 5" x 30" Concrete Survey Monument* | <b>52.00</b>  | <b>44.00</b>  | <b>35.00</b>  |
| <b>CM4X6X30</b> | 4" x 6" x 30" Concrete Survey Monument* | <b>56.00</b>  | <b>50.00</b>  | <b>41.00</b>  |
| <b>CM4X6X36</b> | 4" x 6" x 36" Concrete Survey Monument* | <b>62.00</b>  | <b>56.00</b>  | <b>48.00</b>  |
| <b>CM6X6X36</b> | 6" x 6" x 36" Concrete Survey Monument* | <b>121.00</b> | <b>117.00</b> | <b>112.00</b> |

\* Marker sold separately – see page 14 for pricing.



C

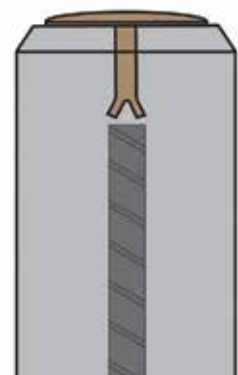

# Quality at its Best!



## CEMETERY MARKERS

### CEMETERY REBAR CAP — special imprint suitable for cemeteries

This special edition cap comes with an imprint suitable for use in cemeteries. Like all our other rebar caps, the cemetery markers are easy to set, won't corrode, and are made of tough aluminum alloy.

| Description  | 25-99 | 100-249 | 250+ |
|--|-------|---------|------|
| 2" Cap w/Cross for 3/8", 1/2" or 5/8" rebar              | 4.33  | 2.80    | 2.70 |
| 2" Cap w/1 Row of Lettering for 3/8", 1/2" or 5/8" Rebar | 4.33  | 2.80    | 2.70 |
| 3 1/4" Cap w/"Block Lot" for 1/2" Rebar                  | 5.36  | 5.00    | 4.68 |
| 3 1/4" Cap w/"Block Lot" for 5/8" Rebar                  | 5.36  | 5.00    | 4.68 |

See the monument cap layout on page 32

### CEMETERY ECOSTAKE — recycled, and the magnet makes it easy to find

The Berntsen Cemetery Ecostake is made of recycled plastic and is UV protected. It will not rot or splinter and contains a magnet in the top that makes later location a snap. The plastic top is imprinted with a four quadrant cross to stamp your Lot & Block numbers.

| Item # | Description                    | 25-99 | 100-299 | 300+ |
|--------|--------------------------------|-------|---------|------|
| ES5LCO | Ecostake 1 5/8" x 24" w/ Cross | 7.60  | 6.80    | 6.00 |

### MULTI-PURPOSE FIELD BAG — repels water, resists puncture, and hard to lose!

The Multi-Purpose Field Bag is designed with the surveyor in mind. It is made of "Tough Duck" PVC backed fabric for maximum strength that will resist tears and repel water. The bottom is layered with "Tough Duck" and a 1000 ballistic nylon fabric to avoid punctures. It is available in Fluorescent Orange. This bag is 5" x 14.5" x 37".

| Item #    | Description             | Each   |
|-----------|-------------------------|--------|
| MFIELDBAG | Multi-Purpose Field Bag | 160.00 |

### LATH BAG — carry up to 50 laths in comfort

The Berntsen Lath Bag is made from the same "Tough Duck" fabric and 1000 ballistic nylon as the Multi-Purpose field bag. This bag is 5" x 14.5" x 32" and will carry 30-50 pieces of lath. Orange in color and has a convenient loop for a hammer and sturdy shoulder strap.

| Item #   | Description  | Each  |
|----------|--------------|-------|
| LATH BAG | 32" Lath Bag | 71.50 |

*"Service is excellent — that is what I have come to expect from Berntsen"* —Colorado

### A. DURANAIL — easier to set, easier to see

The DuraNail, from Berntsen®, is a remarkable new nail that drives into asphalt with ease. The larger nails have an easy-to-see head with a distinct red cross and center punch, making DuraNails a good choice for control. These magnetic nails come with 'The Magnetizer' to realign the magnetic field after nail is installed, making them easier to locate. Available in several sizes to suit your needs.

| Item #                | Description                  | Your Price                   |
|-----------------------|------------------------------|------------------------------|
| <b>DN1</b>            | DuraNail 1"                  | <b>58.00/Package of 200</b>  |
| <b>DN175</b>          | DuraNail 1 3/4"              | <b>48.50/Package of 100</b>  |
| <b>DN2</b>            | DuraNail 2" with Red Cross   | <b>78.00/Package of 100</b>  |
| <b>DN3</b>            | DuraNail 3" with Red Cross   | <b>103.00/Package of 100</b> |
| <b>DN4</b>            | DuraNail 4" with Red Cross   | <b>79.00/Package of 50</b>   |
| <b>DN5</b>            | DuraNail 5" with Red Cross   | <b>91.50/Package of 50</b>   |
| <b>DN8</b>            | DuraNail 8" with Red Cross   | <b>113.00/Package of 50</b>  |
| <b>THE MAGNETIZER</b> | Realigns nail magnetic field | <b>1.00 each</b>             |



Check out Berntsen's®  
**Exclusive**  
**DuraNail**

### B. STEEL NAIL MARKER — poles don't slip off center divot

Made from solid steel, our Steel Nail Markers are easy to drive into tough blacktop. Each is labeled "SURVEY MARK" and comes with a center divot to provide pinpoint accuracy when used as control points.

| Item #       | Description       | Each        |                                    |
|--------------|-------------------|-------------|------------------------------------|
| <b>SNM1</b>  | Steel Nail Marker | <b>1.25</b> | Package of 100                     |
| <b>SNM1B</b> | Steel Nail Marker | <b>1.55</b> | Any quantity outside of a full bag |

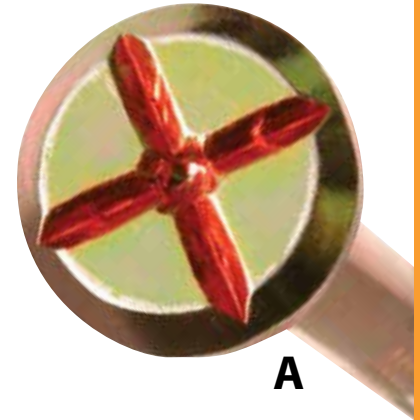

### C. MAGNAIL® SURVEY NAIL — 2 to 4 times easier to find with locator

- Revolutionary new metal formula retains magnetism
- Larger center point makes nail easier to use
- Magnetized for 2-4 times greater detection with a metal locator

| Item #            | Description    | Your Price                  |
|-------------------|----------------|-----------------------------|
| <b>MAGNAIL125</b> | 1 1/4" MagNail | <b>13.50</b> Per Box of 100 |
| <b>MAGNAIL15</b>  | 1 1/2" MagNail | <b>15.50</b> Per Box of 100 |
| <b>MAGNAIL2</b>   | 2" MagNail     | <b>19.50</b> Per Box of 100 |
| <b>MAGNAIL25</b>  | 2 1/2" MagNail | <b>22.50</b> Per Box of 100 |

### D. SURVEY WASHERS — customizable, and large hole fits survey nails

Our brass, aluminum, or stainless steel washers can be custom stamped with your name and license number. There's no stamping charge for orders of at least 100 washers. The center hole is sized for "PK" nails, MagNails®, our Steel Nails, or our new DuraNails. This is a fast, inexpensive marking solution for difficult situations.

| Item #      | Description                            | 25-99       | 100-249     | 250-499     | 500+        |
|-------------|--|-------------|-------------|-------------|-------------|
| <b>AT1</b>  | 1 1/2" Diameter Aluminum Washer        | <b>1.34</b> | <b>1.05</b> | <b>0.90</b> | <b>0.69</b> |
| <b>SST1</b> | 1 1/2" Diameter Stainless Steel Washer | <b>1.39</b> | <b>1.09</b> | <b>0.94</b> | <b>0.90</b> |
| <b>BT1</b>  | 1 1/2" Diameter Brass Washer           | <b>2.17</b> | <b>2.02</b> | <b>1.73</b> | <b>1.58</b> |
| <b>BT2</b>  | 2" Diameter Brass Washer               | <b>2.83</b> | <b>2.50</b> | <b>2.36</b> | <b>1.87</b> |

**Best Price!**

No charge for stamping 100+ washers. Maximum of 28 characters (including spaces). See page 32 for stamping layout.

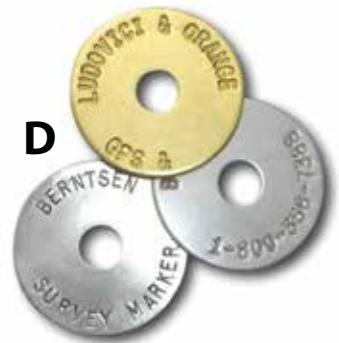

### E. HUB DISCS — stop losing control with these bright discs

This bright yellow and florescent orange plastic washer is stamped 'SURVEY MARKER - DO NOT REMOVE' on each side. Works great with our 1" & 1 3/4" DuraNails and Magnails. Sold in packages of 100.

| Item #         | Description                                   |                             |
|----------------|---|-----------------------------|
| <b>HUBDISC</b> | 1 1/2" Plastic Washer stamped "SURVEY MARKER" | <b>16.50 Package of 100</b> |



# Making your Mark is Easy with these products!



A

**EcoStake™**

## A. ECOSTAKE™ — recycled, won't rot or splinter, and magnetized

The Berntsen® EcoStake™ is made of **recycled plastic** and is UV protected. It will not rot, splinter or split, and is not subject to insect damage. Each EcoStake™ contains a **magnet in the top** that makes later location a snap. The tough plastic top remains legible and this plastic will accept an impression with a steel stamp set. The EcoStake™ is available in two colors and three sizes; each stake is imprinted with a bull's eye cross and the words, "SURVEY MARK".

| Item # | Description                                     | 25-99 | 100-299 | 300+ |
|--------|---|-------|---------|------|
| ES3SMO | EcoStake 1" x 16" Orange                        | 4.30  | 3.50    | 3.20 |
| ES3SMP | EcoStake 1" x 16" Pink                          | 4.30  | 3.50    | 3.20 |
| ES3CP  | EcoStake 1" x 16" w/Cross No Imprint Pink       | 4.30  | 3.50    | 3.20 |
| ES4SMO | EcoStake 1 5/8" x 18" Orange                    | 5.75  | 5.00    | 4.60 |
| ES4SMP | EcoStake 1 5/8" x 18" Pink                      | 5.75  | 5.00    | 4.60 |
| ES5SMO | EcoStake 1 5/8" x 24" Orange                    | 7.60  | 6.80    | 6.00 |
| ES5LCO | EcoStake 1 5/8" x 24" w/Cross No Imprint Orange | 7.60  | 6.80    | 6.00 |

## B. BENCH TIE — our easiest-to-use benchmark

Invented by a surveyor for surveyors, the Bench Tie is easy to set, easy to mark permanently, and easy to use once set, with a recessed dimple on top designed to accept a prism pole tip. A good way to set a long-lasting benchmark in a pole, wall or tree, and also useful for setting into a pre-drilled hole in concrete.

| Item #   | Description                             | 1-19 | 20-99 | 100+ |
|----------|---|------|-------|------|
| BENCHTIE | Vertical Surface Control Point (Yellow) | 4.00 | 3.60  | 3.25 |

## C. DEEP-1® MARKERS — low cost magnets really light up locators

DEEP-1® Markers are a low cost way to preserve underground locations. These colorful, permanent magnets are also an approved way to mark section corner reference points. They're easy to install - just bury them vertically near the monument!

Two color ranges are provided, one coded for sectional survey use, and one coded for marking utilities.

### DEEP-1® Underground Magnetic Marker for Surveys

| Item #  | Description                            | 1-299 | 300+ |
|---------|--|-------|------|
| DEEP1S  | DEEP1 Metallic Silver (NE quadrant)    | 2.05  | 1.65 |
| DEEP1FP | DEEP1 Fluorescent Pink (SE quadrant)   | 2.05  | 1.65 |
| DEEP1C  | DEEP1 Clear (Under the Monument)       | 2.05  | 1.65 |
| DEEP1FB | DEEP1 Fluorescent Blue (SW quadrant)   | 2.05  | 1.65 |
| DEEP1FO | DEEP1 Fluorescent Orange (NW quadrant) | 2.05  | 1.65 |

### DEEP-1® Underground Magnetic Marker for Utilities

|         |                              |      |      |
|---------|------------------------------|------|------|
| DEEP1UG | DEEP1 Green (Sewer)          | 2.05 | 1.65 |
| DEEP1UY | DEEP1 Yellow (Gas)           | 2.05 | 1.65 |
| DEEP1UR | DEEP1 Red (Electric)         | 2.05 | 1.65 |
| DEEP1UB | DEEP1 Blue (Water)           | 2.05 | 1.65 |
| DEEP1UO | DEEP1 Orange (Communication) | 2.05 | 1.65 |

\*Deep-1® Magnetic Markers are packed 300/case. For less than full case quantities unit price is \$2.05 each.

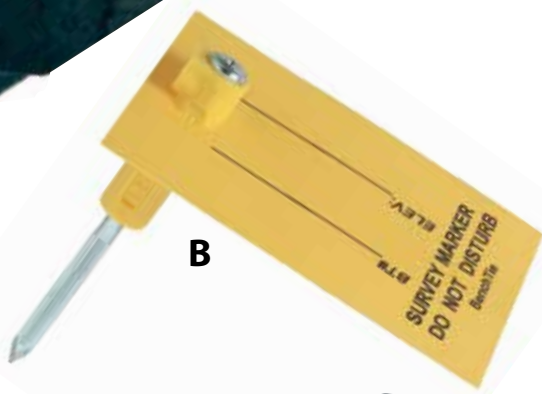

B



C



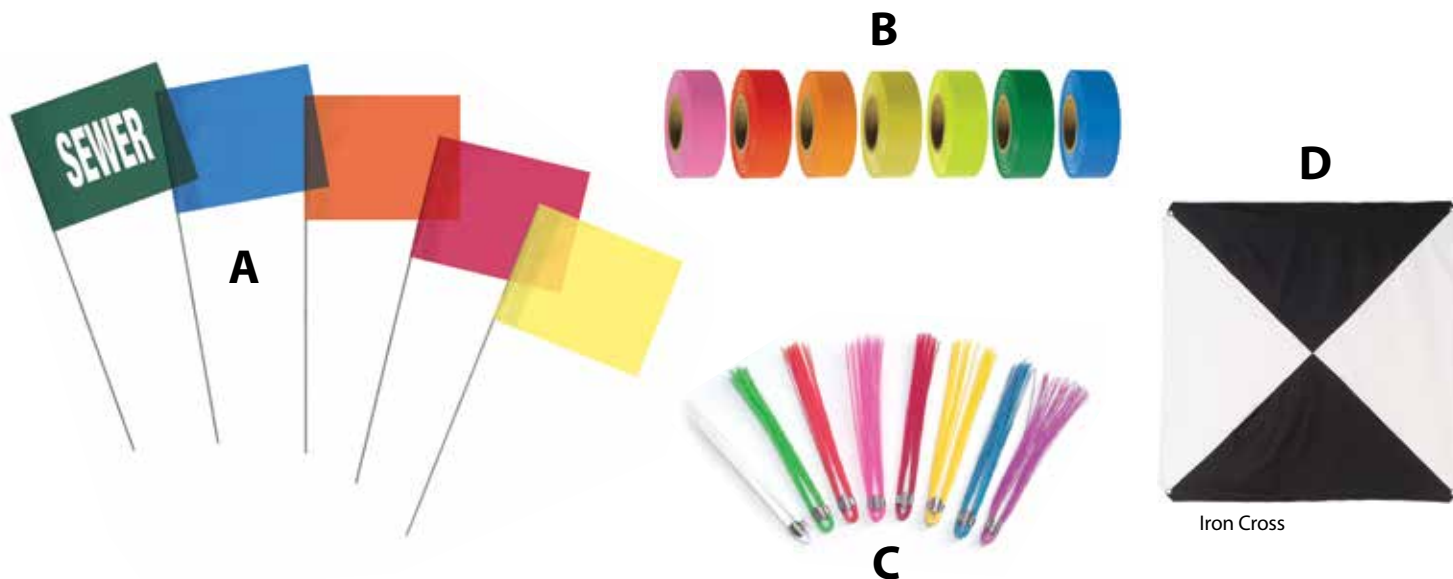

**A. MARKING FLAGS**

Marking flags now available through Berntsen. Long-lasting material and colors, tear resistant for high performance.

| Item #                 | Description                       | Plain Flags       |
|------------------------|-----------------------------------|-------------------|
| <b>MARKING FLAG221</b> | 2-1/2" X 3-1/2" on 21" Wire Staff | <b>65.00/box</b>  |
| <b>MARKING FLAG230</b> | 2-1/2" X 3-1/2" on 30" Wire Staff | <b>78.00/box</b>  |
| <b>MARKING FLAG421</b> | 4" X 5" on 21" Wire Staff         | <b>70.00/box</b>  |
| <b>MARKING FLAG430</b> | 4" X 5" on 30" Wire Staff         | <b>83.00/box</b>  |
| <b>MFTOOL</b>          | Marking Flag Insertion Tool       | <b>99.00 each</b> |

Specify the color: OG = Glo orange, PG = Glo Pink, LG = Glo Lime Green, YG = Glo Yellow, RG = Glo Red, GG = Glo Green, BG = Glo Blue, W = White. Min order: 1000 flags (1 box)

**B. ROLL FLAGGING**

Colorful and highly visible, solid color Roll Flagging, temperature resistance -10°F.

| Item #         | Description                            |
|----------------|--|
| <b>RF150PG</b> | Solid Color 150 ft/roll Glo Pink       |
| <b>RF150OG</b> | Solid Color 150 ft/roll Glo Orange     |
| <b>RF150YG</b> | Solid Color 150 ft/roll Glo Yellow     |
| <b>RF150RG</b> | Solid Color 150 ft/roll Glo Red        |
| <b>RF150LG</b> | Solid Color 150 ft/roll Glo Lime Green |
| <b>RF150GG</b> | Solid Color 150 ft/roll Glo Green      |
| <b>RF150BG</b> | Solid Color 150 ft/roll Glo Blue       |
| <b>RF300W</b>  | Solid Color 300 ft/roll White          |

| 12 - 132 Rolls   | 144 + Rolls      |
|------------------|------------------|
| <b>1.55/roll</b> | <b>1.35/roll</b> |

Min order: 12 rolls (1 box)

**C. MARKING WHISKERS**

6" Marking Whiskers attach to wood stakes or 60-penny nails (not Included).

| Item #             | Description         | Each              |
|--------------------|---------------------|-------------------|
| <b>MK WHISKERS</b> | 6" Marking Whiskers | <b>121.50/box</b> |

Specify the color: OG = Glo orange, PG = Glo Pink, Y= Yellow, W = White, R = Red, O = Orange, G = Green, B = Blue.

Min order: 1000 (1 box - 40 bundles of 25)

**D. AERIAL TARGETS**

Each target is manufactured with reinforced grommets in each corner and is made of 4 mil PVC. Two patterns available, Bulls-Eye or the Iron Cross.

| Item #        | Description                     | Each         |
|---------------|---------------------------------|--------------|
| <b>AT48BE</b> | 48" x 48" w/ Bulls-Eye Pattern  | <b>16.50</b> |
| <b>AT48IC</b> | 48" x 48" w/ Iron-Cross Pattern | <b>16.50</b> |

**E. AERIAL PANELING**

These reusable 4 mil PVC rolls of paneling will save time and labor costs.

| Item #          | Description                       | Each              |
|-----------------|-----------------------------------|-------------------|
| <b>AP12X300</b> | 12" x 300' Roll - Black and White | <b>36.00/roll</b> |
| <b>AP24X300</b> | 24" x 300' Roll - Black and White | <b>72.00/roll</b> |

**F. FLAG POUCH — always keep two rolls handy**

The Flag Pouch holds 2 rolls of flagging tape and comes with a belt loop attached. It is made of Cordura, a tough, 1000 denier, heavy nylon fabric that resists abrasions, punctures and tears and has a urethane coating to repel water. It is available in Fluorescent Orange.

| Item #            | Description                  | Each         |
|-------------------|------------------------------|--------------|
| <b>FLAG POUCH</b> | Flag Pouch for Flagging Tape | <b>41.00</b> |



# Quick, Easy, & won't mar the lettering!

Accessories



**A**

**A. LIXIE HAMMERS — avoid marring caps... with replaceable soft heads**

Lixie dead blow hammers are quick, easy, and accurate to use, and they are the best way to set monuments onto rebar or pipe without marring the lettering. Dead blow hammers have a shot-filled cavity in the head and replaceable urethane heads that hold up well in the field. Berntsen carries several sizes and a complete line of replacement parts.

| Item #  | Description                               | Each   |
|---------|---|--------|
| LX3     | 3 1/2 Pound Hammer w/2" Face/14" Handle   | 67.00  |
| LX6     | 6 1/2 Pound Hammer w/2.5" Face/17" Handle | 107.00 |
| LX7     | 7 Pound Hammer w/2.5" Face/32" Handle     | 158.00 |
| LX10    | 10 1/2 Pound Hammer w/3" Face/19" Handle  | 178.00 |
| LX11    | 11 Pound Hammer w/3" Face/32" Handle      | 211.00 |
| LX300FU | 3 Inch Urethane Replacement Face          | 40.00  |
| LX250FU | 2.5 Inch Urethane Replacement Face        | 27.00  |
| LX200FU | 2 Inch Urethane Replacement Face          | 17.50  |
| LX3HS   | Replacement Handle for LX3                | 23.50  |
| LX6HS   | Replacement Handle for LX6                | 25.50  |
| LX7HS   | Replacement Handle for LX7                | 38.00  |
| LX10HS  | Replacement Handle for LX10               | 26.00  |
| LX11HS  | Replacement Handle for LX11               | 39.00  |

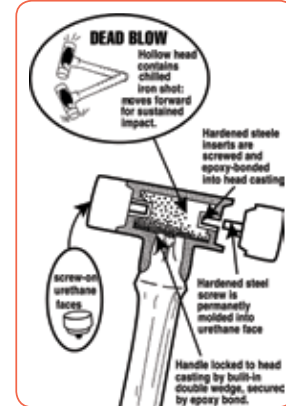

**B. REBAR DRIVERS — custom drivers won't 'mushroom' rebar**

Berntsen rebar drivers are made from strong, heat-treated steel and are exceptionally durable. They provide an ample 2" striking surface and can be used with conventional hammers or our Lixie® urethane faced hammers.

| Item # | Description                  | Each  |
|--------|------------------------------|-------|
| RDRV4  | Rebar Driver for 1/2"        | 55.50 |
| RDRV5  | Rebar Driver for 5/8"        | 55.50 |
| RDRV6  | Rebar Driver for 3/4"        | 55.50 |
| RDRV8  | Rebar Driver for 7/8" and 1" | 55.50 |

*"Your line of products is outstanding."*

*-Michigan*

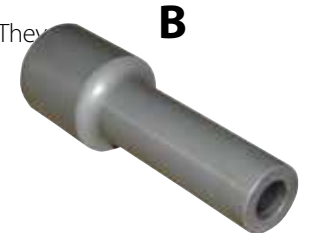

**B**

**C. STAKE DRIVERS — minimize injuries...maximize performance**

STAKE-PRO drivers for plastic and wood stakes virtually eliminates material waste and promotes maximum safety on the job site.

| Item # | Description          | Each  |
|--------|----------------------|-------|
| SP1X1  | Stake Driver 1" x 1" | 23.95 |
| SP2X2  | Stake Driver 2" x 2" | 25.95 |



**C**

**D. TRAFFIC SAFETY SIGNS**

Roadside surveying is one of the most dangerous professions. Federal regulations - and common sense - require that anyone working in or near traffic lanes be protected by high-visibility clothing and advance warning signs. Our fluorescent orange signs and sturdy metal stands aren't just the law... they're a good idea.

| Item # | Description                   | Each   |
|--------|-------------------------------|--------|
| SS1000 | Springless Sign Stand         | 157.00 |
| SS2000 | Sign Stand with Spring        | 199.00 |
| NR36   | 36" x 36" Non-Reflective Sign | 69.00  |
| NR48   | 48" x 48" Non-Reflective Sign | 85.00  |



**D**

## D. STAMP SET — customize monuments in the field

You can mark additional field data into your Berntsen® survey markers with steel letter and number stamp sets. Combination (COMBO) Stamp Set includes characters A-Z, a period, and figures 0 thru 8 (the 6 is also used as a 9). Standard size(s) 1/8" or 3/16" in stock. Custom sizes also available by special order.

| Item #          | Description                                  | Each         |
|-----------------|--|--------------|
| <b>COMBO18</b>  | 1/8" Combination Letter & Number Stamp Set   | <b>64.00</b> |
| <b>COMBO316</b> | 3/16" Combination Letter & Number Stamp Set  | <b>76.00</b> |
| <b>COMBO14</b>  | 1/4" Combination Letter & Number Stamp Set   | <b>81.00</b> |
| <b>STL18</b>    | 1/8" Steel Letter Stamp Set (27 Characters)  | <b>51.00</b> |
| <b>STN18</b>    | 1/8" Steel Number Stamp Set (9 Characters)   | <b>20.00</b> |
| <b>STL316</b>   | 3/16" Steel Letter Stamp Set (27 Characters) | <b>59.00</b> |
| <b>STN316</b>   | 3/16" Steel Number Stamp Set (9 Characters)  | <b>23.00</b> |
| <b>STN14</b>    | 1/4" Steel Number Stamp Set (9 Characters)   | <b>29.00</b> |
| <b>RL/N18</b>   | 1/8" Replacement Letter & Number             | <b>7.00</b>  |
| <b>RL/N16</b>   | 3/16" Replacement Letter & Number            | <b>8.50</b>  |

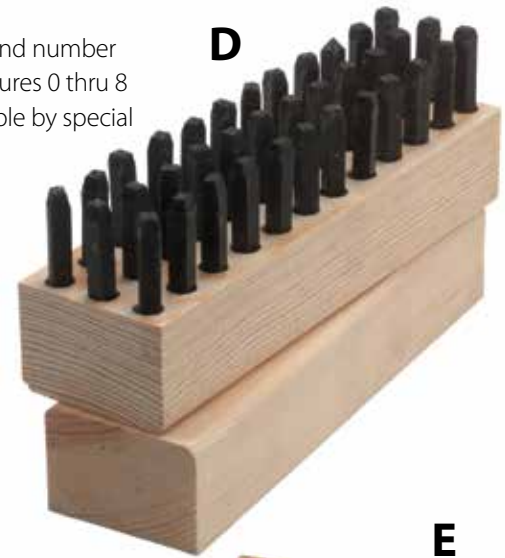

## E. ROTARY STAMP SET — three rotary stamps replace entire stamp set

The rotary stamp set is easier to carry and use than the regular stamp set. Every letter and number found in the regular set is available on just 3 stamp holders. Just dial the rotary stamp holder to the desired character and stamp away! All 3 holders fit into a handy little box (included) and can be carried in a coat pocket.

| Item #        | Description                            | Each          |
|---------------|--|---------------|
| <b>ROS18</b>  | 1/8" Rotary Letter & Number Stamp Set  | <b>390.00</b> |
| <b>ROS316</b> | 3/16" Rotary Letter & Number Stamp Set | <b>390.00</b> |



## F. ANVIL FOR STAMPING REBAR CAPS AND MARKERS

Our anvil is a sturdy little tool that provides a good stamping base when hand stamping Berntsen® rebar caps and concrete markers. Just set the anvil on solid ground and insert the cap.

**Stamping is a lot easier when the cap isn't wobbling!**

| Item #       | Description                               | Each         |
|--------------|---|--------------|
| <b>ANVIL</b> | Anvil for Stamping Rebar Caps and Markers | <b>44.00</b> |



## G. COMBO POUCH — stop losing stamps in the backpack

The Combo Pouch carries our combination letter/number stamp sets. It is made of Cordura, a tough, 1000 denier, heavy nylon fabric that resists abrasions, punctures and tears and has a urethane coating to repel water. It is available in Fluorescent Orange.

| Item #             | Description                     | Each         |
|--------------------|---------------------------------|--------------|
| <b>COMBO POUCH</b> | Pouch for Combo Steel Stamp Set | <b>31.00</b> |



## H. TIMBER SCRIBE — the professional's way to mark trees neatly

If you're a surveyor who scribes trees, *you need this timber scribe!* Designed by a professional surveyor, this scribe features a double-edged cutting blade that forms a **5/8" radius for right or left hand curved letter and number cuts** as well as an additional cutting edge for straight lines. Easy to sharpen with chain saw file, easy to use, and the sturdy leather sheath is included. Made in the USA.

| Item #               | Description                     | Each         |
|----------------------|---------------------------------|--------------|
| <b>TIMBER SCRIBE</b> | Timber scribe w/ leather sheath | <b>87.00</b> |



# Schonstedt

The Best-Known Name in Locators

# Dependable & Sensitive Instruments

# Find it Fast!



### A. SCHONSTEDT® GA-52Cx

**The one piece of equipment you'll never have to worry about—it just works!** This is the original 'yellow stick' that surveyors have relied on for decades. Simple controls, sturdy construction, and a seven-year warranty make this locator a must for any survey shop. The Cx model updates the classic GA-52 with improved sensitivity so you'll find ferrous monuments even when they're deep, damaged, or nearly rusted away. Hard shell plastic case included.

| Item #        | Description and Price              | Suggested List Price |
|---------------|------------------------------------|----------------------|
| <b>GA52Cx</b> | Berntsen Value Price <b>740.00</b> | 915.00               |



### B. SCHONSTEDT® GA-72Cd

Get more information from the digital graph. The GA-72Cd uses the same circuitry as the GA-52Cx, and adds a digital graph that shows signal strength and polarity, and more control options. You can determine the orientation of underground objects, and use the visual guides to pinpoint the location. Headset available, but not needed in most conditions. Comes with five-year warranty and hard shell plastic carrying case.

| Item #        | Description and Price              | Suggested List Price |
|---------------|------------------------------------|----------------------|
| <b>GA72Cd</b> | Berntsen Value Price <b>865.00</b> | 1040.00              |



**TRADE IN SPECIAL**  
 Save up to \$300  
 on a new Schonstedt  
 Contact Berntsen  
 for details!



### C. SCHONSTEDT® GA-92XTi & GA-92XTd

Free up your hands when hauling or using equipment. The XT series of magnetic locators is extendable, so they collapse to less than 16 inches for carrying in a holster, and extend a full 26 inches in use. Controls are 'thumbable' for one-handed use. The XT series has all the legendary Schonstedt sensitivity in a compact housing, and will find ferrous material up to 16 feet underground! The XTi's LCD displays show gain and battery strength, and the XTd adds signal strength and polarity displays. Holster and hard case, and seven-year warranty included.

| Item #         | Description and Price              | Suggested List Price |
|----------------|------------------------------------|----------------------|
| <b>GA92XTi</b> | Berntsen Value Price <b>860.00</b> | 1020.00              |
| <b>GA92XTd</b> | Berntsen Value Price <b>860.00</b> | 1020.00              |

# Up to 18 Tools in 1!

## Imagine the Time Savings!

### C. COBRA COMBI — gas power beats muscle power!

The Cobra Combi gas-powered drill/breaker is manufactured by the same company that made the Pionjar 120, and combines the Pionjar's sturdy effectiveness with a catalytic converter and a new carburetor. This means **the Cobra Combi now meets the tough U.S. EPA Phase 1 emission regulations.** The Cobra Combi comes with 2 tools - a flat chisel and a 1-3/8" drill steel - and can be fitted with up to 18 tools that adapt it for cutting, driving, drilling, compacting, breaking concrete and hundreds of other uses. Berntsen recommends the Cobra Combi for driving our Top Security Rod Monuments and, of course, it is superb for driving any size rebar. The new Cobra Combi also features vibration-dampening handles and is easy to start. See our website, [www.berntsen.com](http://www.berntsen.com), for a look at the full line of attachments available.

List Price 5,145.00

| Item #             | Description               | Each            |
|--------------------|---------------------------|-----------------|
| <b>COBRA COMBI</b> | Gas-Powered Drill/Breaker | <b>4,495.00</b> |

### Cobra Combi RENTAL INFORMATION

The Cobra Combi is a perfect choice for installing our Sectional Rod Monuments or other rod systems that need to be driven "to refusal". The Combi weighs 57 pounds, but with case the shipping weight is 100 pounds. A full line of attachments is available separately from Berntsen. These tools will also fit our previous drill/breaker offering, the Pionjar 120. The hex chuck is 7/8" x 4 1/4".

Rental Charge:

- 95.00/Day\***
- 500.00/Week\***
- 1,900.00/Month\***

\*Plus all shipping charges to and from. Rental starts the day the Cobra Combi ships and ends the day it's received back. Rent with Credit Card only.



| Item #                | Description                                | Each          |
|-----------------------|--|---------------|
| <b>CC9050 3755</b>    | Drill Steel 1-1/4" x 47" Working Length    | <b>214.65</b> |
| <b>CC9050 4245</b>    | Drill Steel 1-5/16" x 31" Working Length   | <b>207.00</b> |
| <b>CC9050 3769</b>    | Drill Steel 1-3/8" x 16" Working Length    | <b>175.00</b> |
| <b>CC9051 0460</b>    | Reamer Bit 3"                              | <b>447.80</b> |
| <b>CCR B35</b>        | Reamer Bit 3.5"                            | <b>475.00</b> |
| <b>CC9000 0296</b>    | Pilot Drill Rod 1" x 31" Working Length    | <b>266.50</b> |
| <b>CC3083 3237 00</b> | Tie Tamper 3-1/2" x 15-1/2" Working Length | <b>131.50</b> |
| <b>CC9245 2823 30</b> | Tie Tamper 3-1/2" x 18" Working Length     | <b>153.00</b> |
| <b>CC9245 2822 40</b> | Tie Tamper 3-1/2" x 22" Working Length     | <b>153.00</b> |
| <b>CC3083 3228 00</b> | 14" Moil Point                             | <b>31.60</b>  |
| <b>CC3083 3229 00</b> | 19" Moil Point                             | <b>32.80</b>  |
| <b>CC3083 3231 00</b> | Wide Chisel 1-3/4" x 9.5" Working Length   | <b>35.40</b>  |
| <b>CC3083 3230 00</b> | Wide Chisel 1-3/4" x 13.5" Working Length  | <b>38.00</b>  |
| <b>CC3083 3232 00</b> | Asphalt Cutter 3" x 18" Working Length     | <b>72.00</b>  |
| <b>CC9245 2812 90</b> | Asphalt Cutter 5" x 14"                    | <b>122.65</b> |
| <b>CC3083 3233 00</b> | 3" Digging Chisel 11" Working Length       | <b>112.50</b> |
| <b>CC3083 3234 00</b> | Digging Spade 4-3/4" x 13" Working Length  | <b>122.65</b> |
| <b>CC9245 2813 81</b> | 29mm Wedge Set                             | <b>87.25</b>  |
| <b>CC9245 2813 51</b> | 34mm Wedge Set                             | <b>93.50</b>  |
| <b>CC3083 3241 00</b> | Ground Rod Driver 1-11/16" x 7-3/4"        | <b>126.50</b> |
| <b>CC3083 3235 00</b> | Clay Spade 5" x 14"                        | <b>126.50</b> |
| <b>CC3083 3236 00</b> | Wedge Chisel 1-3/8" x 15"                  | <b>110.00</b> |
| <b>CC9245 2822 80</b> | Driver Blank 2-1/8" x 7-3/4"               | <b>110.00</b> |
| <b>CC3083 3238 00</b> | Shaft for Tamping Pad                      | <b>50.60</b>  |
| <b>CC3083 3252 10</b> | Tamping Pad Round 6"                       | <b>160.00</b> |
| <b>CC3083 3239 00</b> | Tamping Pad Square 7"                      | <b>144.00</b> |

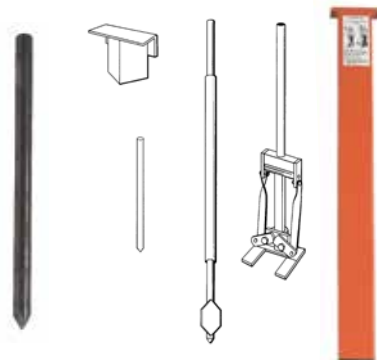

**A**

**A. CARSONITE® FIBERGLASS POSTS — protect the points you set... permanently**

Setting a Carsonite Fiberglass Marker is a fast, inexpensive way to mark and protect your monuments, and under normal conditions is permanent. Setting a Carsonite post is a good way to prevent costly monument damage, saving you time and money. On construction sites, a well-placed **Carsonite post can keep backhoes and other equipment away from important reference points**, preventing long delays and costly layout errors.

Carsonite posts are made from a special fiberglass composite that will not rot or get brittle in harsh weather. Each post is light – about 2 pounds for a 6 foot post – and easy to set in most soil conditions. Carsonite posts come to you with pre-applied standard or custom decals. Driving requires special equipment. A burial depth of at least 18” is recommended.

| Item #              | Description                                | <20          | 20 - 80*     | 100-280*     | 300+*        |
|---------------------|--|--------------|--------------|--------------|--------------|
| <b>CBM6004SM110</b> | 5' Fiberglass Orange Post with SM110 Decal | <b>18.30</b> | <b>14.70</b> | <b>13.85</b> | <b>13.35</b> |
| <b>CBM7204SM110</b> | 6' Fiberglass Orange Post with SM110 Decal | <b>19.70</b> | <b>15.85</b> | <b>14.95</b> | <b>14.40</b> |
| <b>CBM7204</b>      | 6' Fiberglass Orange Post w/ No Decal      | <b>18.45</b> | <b>14.85</b> | <b>14.50</b> | <b>14.00</b> |

| Item #         | Description   | Each          |
|----------------|---|---------------|
| <b>CBMD250</b> | Boundary Marker Driver                                      | <b>133.00</b> |
| <b>D400</b>    | Driver for CRM & CIB Posts                                  | <b>193.00</b> |
| <b>CBMP18</b>  | Pilot Hole Punch  | <b>45.00</b>  |
| <b>CBMFWDC</b> | Featherweight Driving Cap                                   | <b>39.00</b>  |
| <b>RMTLCPP</b> | Post Puller   | <b>331.00</b> |
| <b>DP100</b>   | Pilot Hole Driver   | <b>290.00</b> |
| <b>DECAL</b>   | Vinyl Decal Non-reflective (hundreds to choose from online) | <b>3.40</b>   |
| <b>DECAL-R</b> | Vinyl Decal Reflective (hundreds to choose from online)     | <b>4.60</b>   |

**B. CARSONITE® ROADMARKER POSTS**

The three-rib design provides both flexibility and structural integrity. Two ribs on the side protect decals from impacts while the back rib gives added strength for driving into hard soil.

| Item #         | Description                              | <20          | 20 - 80*     | 100-280*     | 300+*        |
|----------------|--|--------------|--------------|--------------|--------------|
| <b>CRM3060</b> | 5' RoadMarker Fiberglass Post (No Decal) | <b>19.00</b> | <b>15.80</b> | <b>14.30</b> | <b>12.80</b> |
| <b>CRM3072</b> | 6' RoadMarker Fiberglass Post (No Decal) | <b>21.95</b> | <b>17.60</b> | <b>16.75</b> | <b>16.10</b> |



**C. DUAL-SIDED TRAIL MARKERS**

This durable yet flexible fiberglass composite post accepts decals on both sides. The raised, reinforced ribs along each side help prevent scratching or removal of decals if impacted.

| Item #         | Description                              | <20          | 20 - 80*     | 100-280*     | 300+*        |
|----------------|--|--------------|--------------|--------------|--------------|
| <b>CIB3060</b> | 5' Dual Sided Fiberglass Post (No Decal) | <b>16.60</b> | <b>13.75</b> | <b>13.20</b> | <b>12.80</b> |
| <b>CIB3072</b> | 6' Dual Sided Fiberglass Post (No Decal) | <b>20.55</b> | <b>16.95</b> | <b>16.00</b> | <b>14.90</b> |

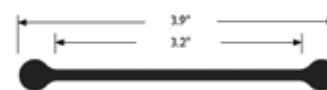

\*20 Posts per case  
Posts with custom decals, please call for price





## Hundreds of Decals TO CHOOSE From

OR CUSTOMIZE YOUR OWN  
AT [www.berntsen.com](http://www.berntsen.com)

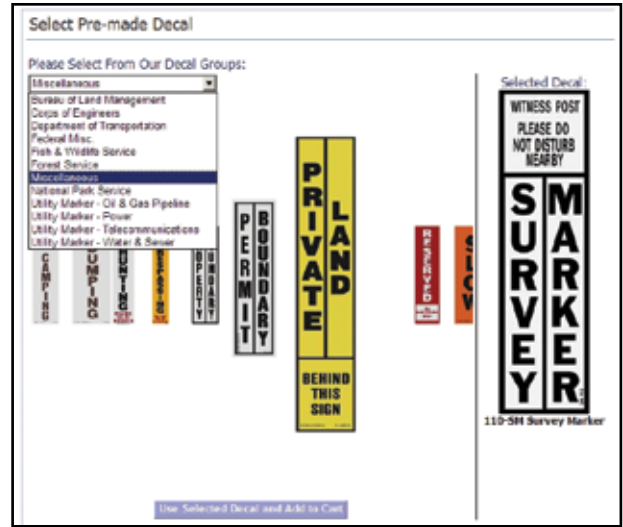

### B. THIN-LINE POST — lightweight and inexpensive, won't rot or get brittle

Berntsen's Thin-Line Post, made of reinforced fiberglass, is lightweight, inexpensive, and will not rot or get brittle when exposed to extreme weather. Can be used to mark right-of-way, corners, reference points, and just about anything else. Comes standard in orange, and 3 standard decals are available - R.O.W., Survey Mark, and Boundary. Call us for information on other colors and custom decals. The Thin-Line Post requires a special driver, sold separately, and should be set at least 2 feet deep.

| Item #              | Description  | <20               | 25 - 75*     | 100-275*     | 300+*       |
|---------------------|--|-------------------|--------------|--------------|-------------|
| <b>TLP5-ORG</b>     | 5 Foot Fiberglass Post Orange with No Decal            | <b>10.41</b>      | <b>9.05</b>  | <b>8.27</b>  | <b>7.62</b> |
| <b>TLP5-SM-ORG</b>  | 5 Foot Fiberglass Post Orange with 'Survey Mark' Decal | <b>12.60</b>      | <b>10.32</b> | <b>9.90</b>  | <b>9.60</b> |
| <b>TLP6-ORG</b>     | 6 Foot Fiberglass Post with No Decal                   | <b>11.38</b>      | <b>9.90</b>  | <b>9.10</b>  | <b>8.36</b> |
| <b>TLP6-BDY-ORG</b> | 6 Foot Fiberglass Post with 'Boundary' Decal           | <b>12.90</b>      | <b>11.20</b> | <b>10.35</b> | <b>9.63</b> |
| <b>TLP6-ROW-ORG</b> | 6 Foot Fiberglass Post with 'R O W' Decal              | <b>12.90</b>      | <b>11.20</b> | <b>10.35</b> | <b>9.63</b> |
| <b>TLP6-SM-ORG</b>  | 6 Foot Fiberglass Post with 'SURVEY MARK' Decal        | <b>12.90</b>      | <b>11.20</b> | <b>10.35</b> | <b>9.63</b> |
| <b>TLPDRV</b>       | Thin-Line Driver                                       | <b>97.00</b> Each |              |              |             |
| <b>TLPDECAL</b>     | Vinyl Decal Non-Reflective                             | <b>3.00</b> Each  |              |              |             |

\*25 Posts per case



Thin-Line post driver

### C. POLYETHYLENE SIGNS — reasonably priced, and customized for you

These sturdy polyethylene signs are bright, long lasting, and versatile. They can be marked with any combination of lettering and symbols desired – just send us a sketch. One color custom printing is free, additional colors cost \$.60 per color per sign. Signs come standard in 2 thicknesses and 3 colors – orange, white and yellow. Call us for information on custom sizes and thicknesses.

| Item #          | Description | 25-49        | 50-99       | 100-249     | 250-499     | 500-999     | 1000+       |
|-----------------|-------------|--------------|-------------|-------------|-------------|-------------|-------------|
| <b>POLY4X6A</b> | 4" x 6"     | <b>7.55</b>  | <b>5.09</b> | <b>4.03</b> | <b>3.86</b> | <b>3.67</b> | <b>3.09</b> |
| <b>POLY6X8A</b> | 6" x 8"     | <b>10.37</b> | <b>7.28</b> | <b>5.62</b> | <b>5.26</b> | <b>4.83</b> | <b>4.39</b> |
| <b>POLY4X6B</b> | 4" x 6"     | <b>9.73</b>  | <b>6.37</b> | <b>5.05</b> | <b>4.84</b> | <b>4.58</b> | <b>3.82</b> |
| <b>POLY6X8B</b> | 6" x 8"     | <b>12.69</b> | <b>9.13</b> | <b>7.31</b> | <b>6.90</b> | <b>6.58</b> | <b>5.81</b> |

Signs are .055 gauge polyethylene with one color ink

Signs are .125 gauge polyethylene with one color ink

Artwork charges: One-time charge \$70.00



**B**

**ROW**

**BOUNDARY**

**SURVEY MARK**

**C**



# Smart Targets & Flat Prisms

## Saving Surveyors Time & Money— One Project at a Time

### RS SMART TARGETS — for verification, documentation & monitoring

Berntsen International, Inc., has launched a new line of permanent precision survey targets and markers. Designed to facilitate precise building, site layout, and monitoring, all RS Smart Targets are made of tough, UV-resistant materials and are intended for discreet, long term, highly precise control monumentation. The RS System includes **over 20 specialized markers** for placement on bridges, roads, buildings, towers, railroad tracks, and anywhere else precise, repeatable control is needed. RS Smart Targets typically include a reflective surface for use with most total stations, and a bull's eye or level line (or ledge) for accurate targeting. When placed on building axes or other critical dimensions, RS control markers can be used by most of the trades associated with large survey and construction projects.

#### ADHESIVE TARGET REFLECTORS

| Item #      | Description                           | 25-49       | 50-99       | 100-249     | 250+        |
|-------------|---------------------------------------|-------------|-------------|-------------|-------------|
| <b>RSZ3</b> | 30 x 30 mm Reflective Adhesive Target | <b>2.65</b> | <b>2.20</b> | <b>2.00</b> | <b>1.90</b> |
| <b>RSZ4</b> | 40 x 40 mm Reflective Adhesive Target | <b>3.35</b> | <b>2.80</b> | <b>2.55</b> | <b>2.40</b> |
| <b>RSZ6</b> | 60 x 60 mm Reflective Adhesive Target | <b>5.80</b> | <b>4.90</b> | <b>4.50</b> | <b>4.20</b> |



RSZ6

#### PLASTIC SMART TARGETS WITH FLAT PRISM (available in red or grey)

| Item #      | Description                          | 1-24        | 25-49       | 50-99       | 100+        |
|-------------|--------------------------------------|-------------|-------------|-------------|-------------|
| <b>RS30</b> | Level Target w/ 30 x 30 mm Reflector | <b>7.20</b> | <b>6.50</b> | <b>5.80</b> | <b>5.40</b> |
| <b>RS40</b> | Level Target w/ Cross Hairs          | <b>5.90</b> | <b>4.50</b> | <b>3.75</b> | <b>3.30</b> |
| <b>RS50</b> | Target w/ 30 x 30 mm Reflector       | <b>7.25</b> | <b>6.50</b> | <b>6.20</b> | <b>5.70</b> |
| <b>RS60</b> | Target w/ 40 x 40 mm Reflector       | <b>8.90</b> | <b>8.10</b> | <b>6.75</b> | <b>6.25</b> |
| <b>RS70</b> | Target w/ Cross Hairs                | <b>5.90</b> | <b>4.50</b> | <b>3.75</b> | <b>3.30</b> |



RS30R

#### LONG DISTANCE TARGETS

| Item #          | Description                            | 1-24         | 25-49        | 50-99        | 100+         |
|-----------------|--|--------------|--------------|--------------|--------------|
| <b>RS AKZ6</b>  | Plastic Target w/ 60 x 60mm Reflector  | <b>14.95</b> | <b>12.95</b> | <b>11.60</b> | <b>10.75</b> |
| <b>RS ALU22</b> | Metal Target w/ 220 x 220 mm Reflector | <b>77.25</b> | <b>68.25</b> | <b>63.00</b> | <b>60.25</b> |



RS50R

#### INDOOR CONSTRUCTION LEVEL TARGETS

Protect your work and avoid costly mistakes on-site.

| Item #      | Description                                   | 25-49       | 50-99       | 100-249     | 250+        |
|-------------|---|-------------|-------------|-------------|-------------|
| <b>RS11</b> | Construction Level Target w/ Adhesive Backing | <b>3.00</b> | <b>2.50</b> | <b>2.25</b> | <b>2.10</b> |
| <b>RS21</b> | Construction Level Target w/ Stubs            | <b>3.15</b> | <b>2.60</b> | <b>2.50</b> | <b>2.20</b> |



RS11



RS AKZ6R



RS60G

# Protect Your Work and Avoid Costly Mistakes On-site

## REFLECTIVE SURVEY TARGETS & PRISMS — get better data and increase productivity

Great for back-sights, check shots, elevation references and monitoring situations, reflective RS Smart Targets are the best way to take advantage of your investment in high tech survey equipment. Save crew time, keep employees out of danger, get better data, and feel more secure about construction layout. Can you afford not to use RS Smart Targets?

### PLASTIC SMART ANGLE TARGETS (available in red or grey)

| Item #       | Description                                   | 1-24         | 25-49        | 50-99        | 100+         |
|--------------|---|--------------|--------------|--------------|--------------|
| <b>RS80</b>  | Angle Target w/ 2 Target Reflectors 40 x 40mm | <b>17.50</b> | <b>16.50</b> | <b>13.75</b> | <b>12.65</b> |
| <b>RS90</b>  | Angle Target w/ 3 Target Reflectors 40 x 40mm | <b>21.25</b> | <b>19.10</b> | <b>16.85</b> | <b>15.55</b> |
| <b>RS100</b> | Angle Target w/ 4 Cross Hairs                 | <b>12.95</b> | <b>10.85</b> | <b>9.50</b>  | <b>8.40</b>  |



RS80R

### ADAPTER WITH SMART ANGLE TARGETS

| Item #         | Description                               | 1-24         | 25-49        | 50-99        | 100+         |
|----------------|---|--------------|--------------|--------------|--------------|
| <b>RSAK130</b> | Adapter w/ 2 Target Reflectors 30 x 30 mm | <b>18.95</b> | <b>17.75</b> | <b>16.25</b> | <b>15.25</b> |
| <b>RSAK80</b>  | Adapter w/ Angle Target RS80              | <b>30.95</b> | <b>25.75</b> | <b>23.75</b> | <b>22.15</b> |
| <b>RSAM80</b>  | Metal Adapter w/o thread & Target RS80    | <b>62.95</b> | <b>52.30</b> | <b>48.25</b> | <b>44.80</b> |
| <b>RSAMG80</b> | Metal Adapter w/ thread & Target RS80     | <b>66.95</b> | <b>55.75</b> | <b>51.50</b> | <b>47.75</b> |



RSAK80R

### LASER SCANNER TARGET MARKERS

| Item #        | Description                 | 1-24        | 25-49       | 50-99       | 100+        |
|---------------|-----------------------------|-------------|-------------|-------------|-------------|
| <b>RSL300</b> | Laser Scanner Target Marker | <b>7.25</b> | <b>6.50</b> | <b>5.80</b> | <b>5.35</b> |



RSL300



RSMP15



RSAMGR80R

### MINI PRISM ANGLE TARGET

| Item #        | Description                        | 1-4           | 5-9           | 10+          |
|---------------|------------------------------------|---------------|---------------|--------------|
| <b>RSMP15</b> | Angle Target w/ 12.7 mm mini prism | <b>112.95</b> | <b>105.95</b> | <b>99.95</b> |

### ADHESIVE FOR SMART TARGETS

| Item #          | Description   | Each         |
|-----------------|---|--------------|
| <b>UV6800</b>   | Multi-purpose Adhesive 10.2 oz. (fits Std. Caulk Gun) | <b>13.25</b> |
| <b>UV6800-3</b> | Multi-purpose Adhesive 3.7 oz (Squeeze Tube)          | <b>8.00</b>  |



UV6800-3

**LEVELING WALL MARKER** A precision 4" stainless steel mark designed for precise leveling and features evenly spaced ridges for anchoring in walls, rocks and tunnels.

| Item #       | Description                               | 1-24         | 25-99        | 100+         |
|--------------|---|--------------|--------------|--------------|
| <b>SSLWM</b> | Leveling Wall Marker (4" Stainless Steel) | <b>16.95</b> | <b>14.95</b> | <b>13.50</b> |



# DISCOVER | ONLINE THE ADVANTAGES OF | ORDERING



*"It's a great way to shop. Wish other sites were more like yours."*

*- West Virginia*

## ONLINE CUSTOMIZATION

Create and preview your custom survey markers and monuments before you order. We even keep your previous layouts for easy re-ordering.

## REAL-TIME SHIPPING CHARGES

Choose your method of UPS shipping (ground, next-day air, etc.) and we'll calculate your shipping charges as you add to your order.

## DELIVERY TRACKING

Tracking number and delivery confirmation sent via email for all orders shipping out of our Madison office.

## ONLINE ORDER HISTORY

View order status of all recent orders in one simple interface as well as view a complete order history.



FIND US ON FACEBOOK AND YOUTUBE



**Berntsen**  
 Marking the Infrastructure of the World™  
 800.356.7388 www.berntsen.com

**FAX OR MAIL THIS ORDER FORM  
 OR ORDER ONLINE AT  
 WWW.BERNTSEN.COM**

2013

PO Box 8670  
 Madison, Wisconsin 53708-8670 USA  
 TOLL-FREE FAX 800-249-9794  
 TOLL-FREE Telephone: 800-356-7388  
 Email: surveymark@berntsen.com • www.berntsen.com

Is this your first order from us?  Yes  No

**METHOD OF PAYMENT**

VISA  MasterCard  American Express  Discover  Payment Enclosed  
 (Please make your check payable to Berntsen International, Inc.)

Name on Card \_\_\_\_\_ Credit Card No. \_\_\_\_\_

Date \_\_\_\_\_ Signature \_\_\_\_\_ Expiration Date \_\_\_\_\_ CVV2 Code \_\_\_\_\_

**MAIL TO**

Type or Print

Company \_\_\_\_\_

PO Box or Street Address \_\_\_\_\_

\_\_\_\_\_

City, State, Zip Code \_\_\_\_\_

Telephone \_\_\_\_\_ Fax \_\_\_\_\_

Signature of Authorized Person \_\_\_\_\_

Email Address \_\_\_\_\_

**SHIP TO** (Shipments must have street address)

Type or Print

Company \_\_\_\_\_

Street Address \_\_\_\_\_

Suite, Room, Building \_\_\_\_\_

City, State, Zip Code \_\_\_\_\_

Telephone \_\_\_\_\_

Attention \_\_\_\_\_

Title \_\_\_\_\_

**DELIVERY** - We ship by UPS or truck freight depending on the total weight and number of packages in your order. Next Day, Second Day Air, and 3 Day Select shipping via UPS is also available. Please ask for details and cost.

**PAYMENT** - We accept MasterCard, Visa, American Express, and Discover. You can also prepay by check.

**SHIPPING & HANDLING** - Prices do not include shipping charges. Please call, fax, or email for costs on your order, or add 15% for shipping & handling on BERNTSEN, PERMAMARK and MORASSE products. On all other items, such as CARSONITE, call for costs.

**SALES TAX** - Wisconsin resident: Add applicable State, City, and County sales tax(es).

**CUSTOM DESIGNED DESIGNS AND LOGOS** - Call for quotation. Camera-ready artwork may be required. For custom stamped logos we also accept artwork as .tif files. For engraved logos please furnish artwork in .dxf and .dwg file format.

**CUSTOM MONUMENTS** - We welcome the opportunity to quote on custom survey marker and monument designs to meet your specifications.

**TERMS** - Terms and prices are subject to change without notice. Because product innovation is a continuing endeavor at Berntsen, specifications and prices are subject to change without notice.

**SURVEYLOG VOLUME 2013 SUPERSEDES ALL PREVIOUS PRICE LISTS**

The unique design and layout of this brochure and the products depicted herein, and the arbitrary, distinctive numbering system for Berntsen products all originated with Berntsen International, Inc. and are the result of years of research by Berntsen to determine not only exactly what our customers wanted, but to best present our customers with the wide range of products available from Berntsen. No copying or reproduction of the format of this brochure or any of the designs, layouts, drawings, or combinations of designs or parts manufactured by Berntsen is permissible without the express written consent of Berntsen International, Inc.. Many Berntsen products are protected by U.S. Patents including 243,159; 243,319; 3,087,945; 4,502,258; 3,748,795; 4,625,473. Other patents pending.

- Prices do not include shipping charges.
- Price list is based on standard stamped lettering only. Please call for quotation on custom made and engraved markers with custom logos.
- Lettering is recessed from the surface.

- Use standard layout forms on reverse side for personalized markers.
- No stamping charge on 11+ markers using standard stamping layout (\$35.00 stamping set-up charge for 1 to 10 markers).
- All prices are in U.S. Dollars.

**Office hours are 8:00am to 4:30pm Central Time, Monday through Friday. Voice mail available at all other times. Email and Fax operate 24 hours a day.**

| QUANTITY | ITEM NUMBER | DESCRIPTION | UNIT PRICE | TOTAL PRICE |
|----------|-------------|-------------|------------|-------------|
|          |             |             |            |             |
|          |             |             |            |             |
|          |             |             |            |             |
|          |             |             |            |             |
|          |             |             |            |             |
|          |             |             |            |             |
|          |             |             |            |             |
|          |             |             |            |             |

\*Add 15% for Shipping & Handling on Berntsen, Permamark and Morasse products for delivery in the 48 contiguous states (not including Alaska or Hawaii). For all other items, please call for estimate of shipping charges.

|                          |  |  |
|--------------------------|--|--|
| Sub Total                |  |  |
| *15% Shipping & Handling |  |  |
| Tax (Wisconsin Only)     |  |  |
| <b>Total US \$</b>       |  |  |

# Layouts for Personalized Survey Monuments

Note: Drawings are not to scale.

Enclose this handy drawing with your order for Berntsen Survey Caps or Survey Monuments, or PERMAMARK® caps.

It's easy to design your own survey cap!

1. Select a center design (if any desired) or your personalized Berntsen Survey Cap or Survey Monument. Draw that design on the layout for the size cap you are ordering.
2. Fill in blank spaces with the lettering you want on your cap. All letters, numbers, and characters, including periods, take up one full space. Lettering may face "in" or "out" but is usually placed so that one may read the cap from one position.
3. Use the drawing at the bottom of the page for PERMAMARK plastic caps. Standard center designs are not available for PERMAMARK caps. Lettering on PERMAMARK is "straight-across" only.

It's **Easy**  
to Design Your Own  
Survey Caps!

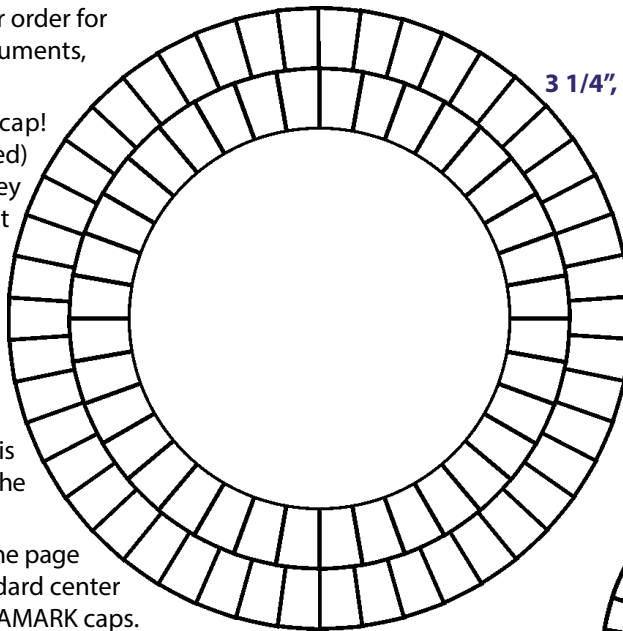

3 1/4", 3 1/2" & 4"

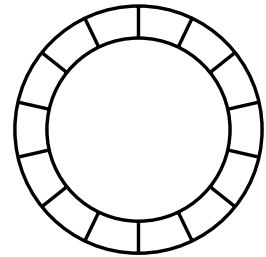

BP1P & BP2 Layout

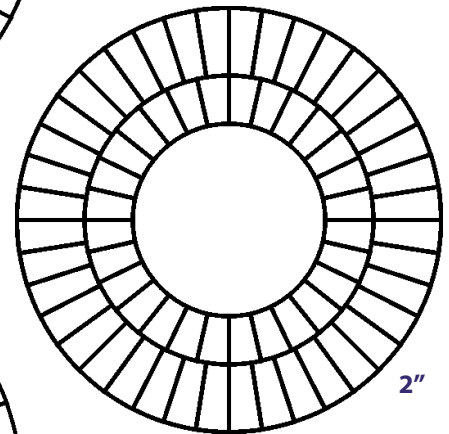

2"

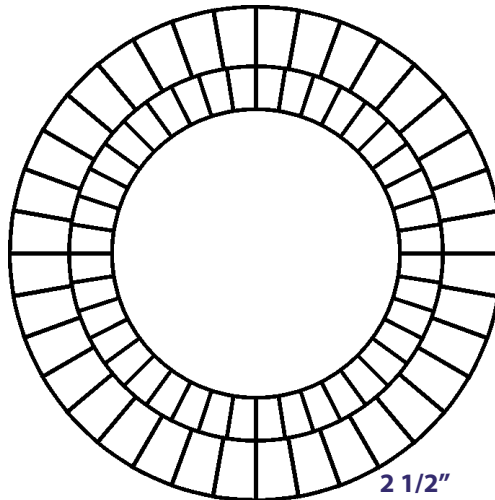

2 1/2"

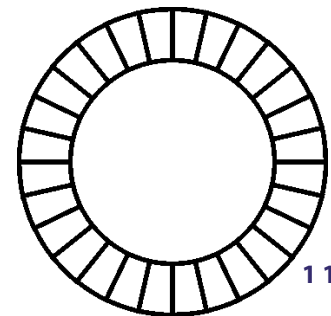

1 1/2"

### Standard Center Designs

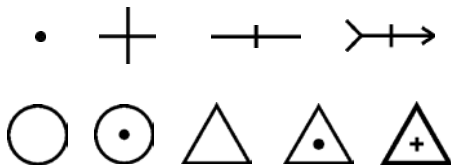

No Center Design Needed

### PERMAMARK Color Choices

Yellow  Red  Orange  Pink

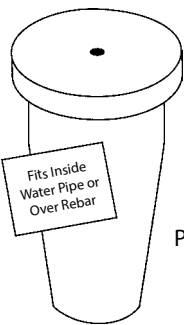

### Standard Layout for PERMAMARK

Lettering is straight across only. All come with center "hole".

PERMAMARK 1/2" ID Pipe  
or 3/8" Rebar Cap

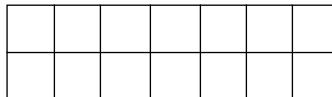

PERMAMARK 3/4" ID Pipe  
or 1/2" Rebar Cap

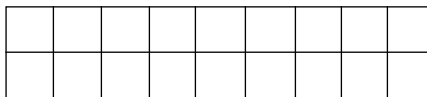

PERMAMARK 1" ID Pipe  
or 5/8" Rebar Cap

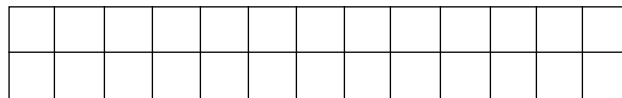

PERMAMARK for  
3/4" Rebar

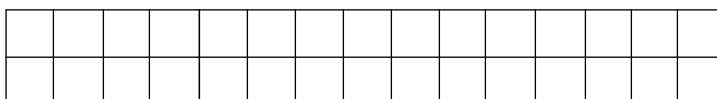

### 2" Standard Layout

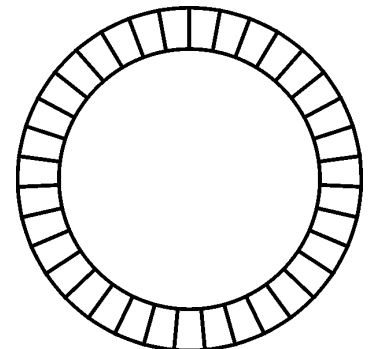

## Morasse® Plastic Survey Caps Layout

- Available with your name and number at no extra cost
- Easy to read RAISED letters
- Large diameter cap surface has enough room for stamping additional data in the field with standard steel stamp sets
- Permanently colored...available in bright orange, red/orange, yellow, blue, green, and now pink
- Easy to tap in...difficult to remove
- Unique open center allows bar to "mushroom" over cap during driving...helps prevent removal of cap

Use the layout below for MORASSE plastic caps. Be sure to indicate your style and color choice and send this layout with the order form.

G41 & G41F = 1 3/4" diameter cap for 3/8" rebar  
 G42 & G42F = 1 3/4" diameter cap for 1/2" rebar  
 G43 & G43F = 1 3/4" diameter cap for 5/8" rebar

P41 & P41F = 2 3/8" diameter cap for 3/8" rebar  
 P42 & P42F = 2 3/8" diameter cap for 1/2" rebar  
 P43 & P43F = 2 3/8" diameter cap for 5/8" rebar

M41 & M41F = 2 3/4" diameter cap for 3/8" rebar  
 M42 & M42F = 2 3/4" diameter cap for 1/2" rebar  
 M43 & M43F = 2 3/4" diameter cap for 3/8" rebar  
 M44 & M44F = 2 3/4" diameter cap for 3/4" rebar or 1/2" pipe

C41 & C41F = 2 3/4" square cap for 3/8" rebar  
 C42 & C42F = 2 3/4" square cap for 1/2" rebar  
 C43 & C43F = 2 3/4" square cap for 3/8" rebar  
 C44 & C44F = 2 3/4" square cap for 3/4" rebar or 1/2" pipe

All cap numbers ending with "F" have a capped center. Those caps without this designation have a center hole with ribs.

### "C" Style (Square)

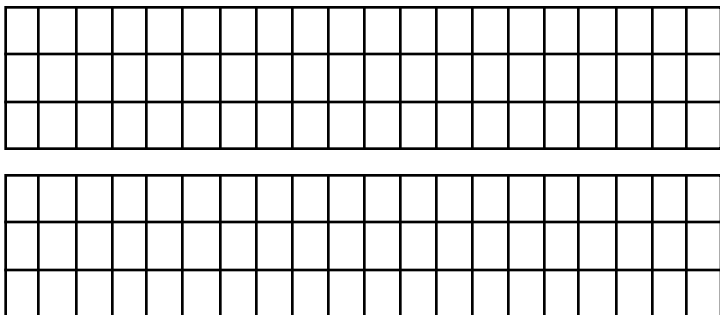

3 lines are available on the upper and bottom part of cap (total 6 lines). On each line: 20 letters of 1/8" or 16 letters of 1/4"

### Standard Center Designs

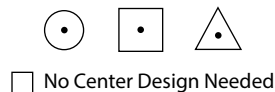

### Color Choices

- Bright Orange
- Red/Orange
- Blue
- Yellow
- Green
- Pink

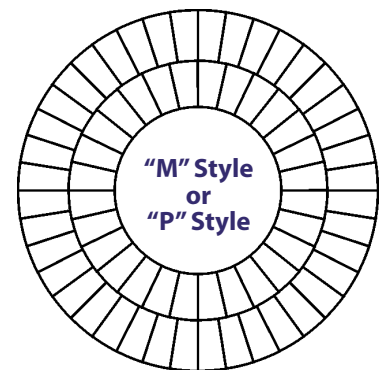
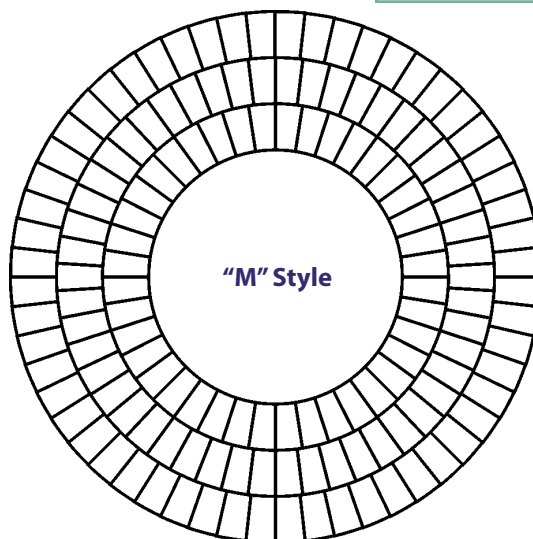
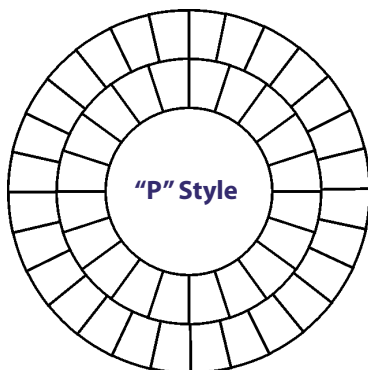
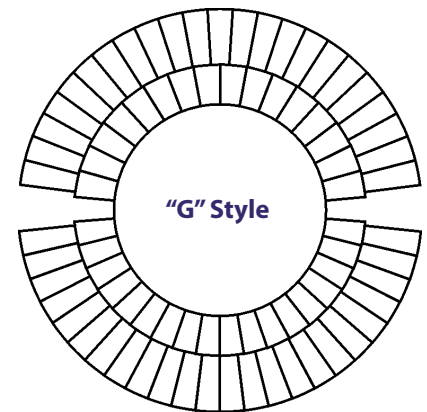
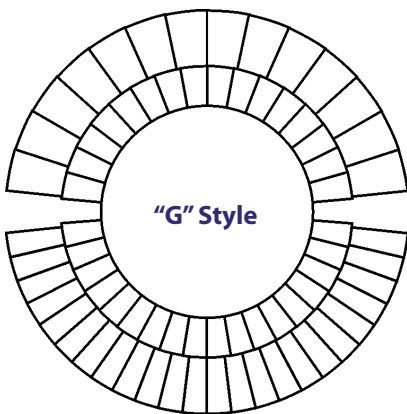

# Easy as 1, 2, 3...

## WHEN IT COMES TO UNDERGROUND UTILITIES,

### BERNTSEN'S MOBILE RFID READER WITH TRIMBLE THING-MAGIC INSIDE & **BERNTSEN'S INFRAMARKER™ SYSTEM 'JUST WORKS'**

Underground assets can be tangled and complicated, especially in cities. This means, of course, that utility locating can be complicated. And technologically speaking, utility locating has been a stagnant sector for decades—pipe and cable locators, based on detection of induced frequencies, have been around since the 1950s, and haven't changed much.

But there is one exciting innovation in underground asset location: magnetic radio frequency identification or RFID markers. Placed at key asset points, Berntsen International's patent pending InfraMarkers, based on the unique synergy between passive magnetic locating and passive battery-free read/write RFID technology, enable precise subsurface utility location and asset verification that is very fast, secure, and as easy as 1, 2, 3...



Use GPS or maps and landmarks to quickly find the approximate location of your utility asset (to get within a few meters).



Use a fast, convenient magnetic locator to precisely locate highly magnetic RFID InfraMarkers, which are placed at end points, angle points, valves, fiber optic splices, elevation changes, asset intersection points, and any other important underground asset locations (to get within an inch or so).

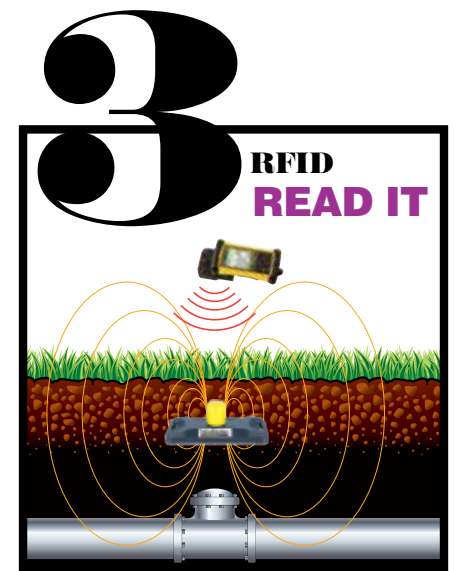

Use Berntsen's InfraMarker Mobile RFID Reader or Trimble's NOMAD RFID reader (both feature Trimble ThingMagic RFID electronics) to verify the identity of the pipe, cable, or other GIS asset feature you're locating.

Combining the speed and precision of magnetic locating with the security of RFID identification is revolutionizing underground utility location. And the InfraMarker system helps with a lot more than location; it's also bringing speed and security into the GIS/IT office.



**FOR MORE INFORMATION VISIT  
WWW.INFRAMARKER.COM**

### RFID-READY IN HOURS: THE INFRAMARKER DESKTOP & MOBILE APPLICATIONS

The whole point of RFID markers is to store useful information in the field — like type of utility, asset type, marker depth, utility depth, nearby utilities, intersections, hazards, ID numbers, etc., even records for land asset or parcel management — right on the marker.

InfraMarker provides an easy-to-use, Windows-compatible system that you can use in the field and office. The GIS/IT departments can quickly commission RFID markers with your preferred system data map or “schema” right in the office. Field technicians can use the same system “schema” to identify and update RFID markers in the field. You can even have multiple utilities and multiple schemas and tell which markers belong (or don’t belong) to which utility group.

### FEATURES OF THE SYSTEM INCLUDE:

- Easily import .CSV file or Excel spreadsheet information
- Tag data map or schema formats are user-defined – you decide what’s important
- Compatible with other Trimble/ThingMagic products
- No time consuming software development kit (SDK) learning or code writing is needed; the InfraMarker system is ready to go without code or customization
- Read and update tag data in the field, without digging up markers
- 64 Characters of extended data in addition to the tag “ID” number
- Minimum 2 alpha numeric characters per field
- Import/export GIS data available
- Works with office computer hardware you may already own. Just load InfraMarker desktop software, develop your data map schema, and add a USB Trimble/ThingMagic RFID reader. Connect the USB cord and start commissioning your RFID tags.
- Works with field computer hardware you may already own, like Trimble’s Nomad Computer, a Trimble/ThingMagic RFID reader and InfraMarker software to your Nomad 6.1 Windows Mobile computer. Just attach the reader, connect the USB cord and read/write your commissioned tags in the field.
- InfraMarker software Mobile applications can even be deployed on some qualified Android smartphones. Just add Berntsen’s InfraMarker Mobile RFID Reader with Trimble/ThingMagic inside. It connects via Bluetooth ... no USB cord needed.
- The unique InfraMarker Mobile RFID Reader even connects to some dash-board/truck-mounted field computers like Trimble YUMA (Windows) as well as qualified field computers running Windows Mobile. That’s versatile hardware and software!
- InfraMarker operates on the standard Class 1 Gen 2 RFID frequency for all assets



RFID is a mature technology that has already simplified the management of inventory and assets in fields as diverse as aerospace, military logistics, manufacturing, retail, and shipping. Berntsen International’s rugged, easy-to-use InfraMarker Magnetic/RFID markers work together with proven Trimble/ThingMagic RFID technology and InfraMarker’s field and office software solutions to bring RFID convenience and power to the management of underground utility and virtually any other GIS assets.



# SURVEYLOG

BERNTSEN® SURVEY PRODUCTS CATALOG • THE SOURCE FOR YOUR SURVEY PRODUCT NEEDS

## NEW AND NOTABLE

### COUNTERSINK DRILL BITS

#### A SIMPLE WAY TO SET PERFECTLY RECESSED CONCRETE MARKERS FAST!!!

- Available in all four sizes for our Berntsen Concrete Markers
- NOW available in SDS-PLUS
- Check out our online YouTube Video <http://www.youtube.com/user/BerntsenIntl>

See page 15 for our full-line of drill bits



### SMART TARGETS, PRISMS & REFLECTORS

#### THE NEW STANDARD IN SURVEYING

- Ensure permanent documentation and evidence of all measurement points
- Simplify the tasks of making observations
- Monitor movements of buildings, bridges, railroads and anywhere precise, discreet monumentation is needed

See pages 28-29 for full list of products



 Find us on Facebook

Become a Berntsen Fan on Facebook.

Visit [www.berntsen.com/Facebook](http://www.berntsen.com/Facebook) for details.